



CATALOGO GADGET
PERSONALIZZABILI
2019/ 2020

Soluzioni pubblicitarie
per esaltare il Tuo BUSINESS

promosolution 2020|2021

THE BRIDGE
LACROIX
HUGO BOSS
CERRUTI
UNGARO
CACHAREL
LAVILLE PARIS
BOUQUET DE PROVENCE
VERY



AB 0208 BORSA DONNA

Borsa donna in pelle bovina conciata al vegetale, doppio manico, chiusura con zip, dotata di tracolla. Made in Italy.

T H E B R I D G E



Pelle



50 x 34 x 4 cm



1



AB 0211 CARTELLA PORTADOCUMENTI

Professionale in pelle bovina conciata al vegetale tinta a mano, doppio manico, scomparto principale con cerniera, tasca interna porta computer, portapenna, portaocchiali e porta cellulare, tracolla rimovibile, Made in Italy.

T H E B R I D G E



Pelle



40 x 31 x 15 cm



1



AB 0209 ZAINO

In pelle bovina conciata al vegetale tinta a mano, chiusura a zip con doppio cursore, tasca esterna portaoggetti. Made in Italy.

T H E B R I D G E



Pelle



26 x 32 x 12 cm



1



AB 0212 ZAINETTO DONNA

Zaino in pelle bovina conciata al vegetale tinta a mano, pattina frontale e chiusura con passante, tasca interna con zip. Made in Italy.

T H E B R I D G E



Pelle



26 x 32 x 15 cm



1



AB 0230 BORSA DONNA

Borsa donna pelle bovina conciata al vegetale tinta a mano, tasca interna con zip, tasca esterna. Made in Italy.

T H E B R I D G E



Pelle



40 x 28 x 14 cm



1



AB 0231 MINI BAG

Borsa donna con tracolla, in pelle bovina conciata al vegetale tinta a mano. Made in Italy.

T H E B R I D G E



Pelle



21 x 14 x 4 cm



1



**AB 0207
BORSA DONNA**

Borsa con tracolla in pelle bovina conciata al vegetale tinta a mano, pattina frontale e chiusura con bottone automatico, tasca interna con zip. Made in Italy.

-  Pelle
-  23,5 x 21 x 9 cm
-  1

T H E B R I D G E



**AB 0225
PORTAFOGLI
DONNA**

In pelle bovina conciata al vegetale tinta a mano, 2 scomparti interni, chiusura con zip. Made in Italy.

-  Pelle
-  18 x 11 x 2 cm
-  1

T H E B R I D G E



**AB 0226
PORTAFOGLI
DONNA**

In pelle bovina conciata al vegetale tinta a mano, 2 scomparti interni più tasca con zip, pattina porta tessere. Made in Italy.

-  Pelle
-  17 x 10,5 x 1 cm
-  1

T H E B R I D G E



**AB 0219
BORSA DONNA**

Borsa donna in pelle bovina conciata al vegetale tinta a mano con inserti intrecciati, chiusura con linguetta, manico e tracolla regolabili. Made in Italy.

T H E B R I D G E

Pelle



35,5 x 26,5 x 16 cm



1

**AB 0222
ZAINO DONNA**

Zaino donna in pelle bovina conciata al vegetale tinta a mano con inserti intrecciati, chiusura a zip con doppio cursore, tasca esterna portaoggetti. Made in Italy.

T H E B R I D G E

Pelle



26 x 32 x 12 cm



1



AB 0206
BORSA DONNA

Borsa donna in pelle bovina conciata al vegetale tinta a mano, tasca interna con zip. Made in Italy.



Pelle



48 x 31,5 x 14 cm



1

T H E B R I D G E



AB 0214
BORSA DONNA

Borsa donna in soffice pelle di mucca, tasca interna con zip. Made in Italy.



Pelle



31 x 21 x 11 cm



1

T H E B R I D G E





MA



NE

**AB 0210
ZAINO**

in pelle bovina conciata al vegetale tinta a mano, due scomparti con chiusura a zip con doppio cursore, scomparto principale con tasca portacomputer imbottita, scomparto secondario con due tasche portaoggetti. Made in Italy.

T H E B R I D G E



Pelle



30x40x12 cm



1

AB 0196 CARTELLA PORTADOCUMENTI

Cartella professionale in pelle bovina conciata al vegetale, tinta a mano, ampio scomparto principale con doppia tasca imbottita porta computer e porta tablet, chiusura a zip con doppio cursore. Doppia tasca esterna con chiusura a zip. Doppio manico e tracolla rimovibile. Made in Italy.



Pelle



38 x 28 x 6,5 cm



1

T H E B R I D G E



GRANDI FIRME



NE

AB 0195 CARTELLA PORTADOCUMENTI

Cartella professionale in pelle bovina conciata al vegetale, tinta a mano, ampio scomparto principale con doppia tasca imbottita porta computer e porta tablet, chiusura a zip con doppio cursore. Doppia tasca esterna con chiusura a fibbia. Doppio manico e tracolla rimovibile. Made in Italy.



Pelle



38 x 28,5 x 12 cm



1

T H E B R I D G E



**AB 0245
PORTAFOGLI UOMO**

In pelle bovina conciata al vegetale tinta a mano, chiusura a zip, varie tasche esterne e scomparti porta carte di credito su entrambi i lati. Made in Italy.

T H E B R I D G E



Pelle



12,5 x 9,5 x 1 cm



1



**AB 0241
PORTAFOGLI UOMO**

In pelle bovina conciata al vegetale tinta a mano, varie tasche interne e scomparti porta carte di credito, tasca porta monete con chiusura a zip. Made in Italy.

T H E B R I D G E



Pelle



25 x 9,5 x 1 cm



1



**AB 0289
TRACCOLLA**

In pelle bovina conciata al vegetale tinta a mano, scomparto principale con cerniera, tasca interna portaocchiali, porta cellulare, porta penna, tasca esterna con zip. Made in Italy.

T H E B R I D G E



Pelle



22,5 x 25 x 7 cm



1



**AB 0290
TRACCOLLA**

In pelle bovina conciata al vegetale tinta a mano, scomparto principale con cerniera, tasca interna porta tablet, portaocchiali, porta cellulare, tasca esterna con zip. Made in Italy.

T H E B R I D G E



Pelle



22,5 x 25 x 4 cm



1



**AB 0265
MOUSE PAD**

In pelle bovina conciata al vegetale tinta a mano. Made in Italy.

T H E B R I D G E



Pelle



20 x 24 cm



1



**AB 0250
PORTA IPAD**

In pelle bovina conciata al vegetale tinta a mano. Made in Italy.

T H E B R I D G E



Pelle



21,4 x 25,6 cm



1



**AB 0283
NECESSAIRE**

In pelle bovina conciata al vegetale tinta a mano, con chiusura a zip. Made in Italy.

T H E B R I D G E



Pelle



23 x 14 cm



1



**AB 0273
CINTURA UOMO**

Cintura in vera pelle bovina con fibbia in metallo lucido. Made in Italy.

T H E B R I D G E



Pelle



lungh. 125 cm



1



**AB 0406
PORTACHIAVI**

Portachiavi HUGO BOSS in pelle gofrata con particolari in acciaio inossidabile. Confezione in astuccio.

HUGO BOSS



-  Pelle
-  3,2 x 3 x 8 cm
-  1



**AB 0404
SET MANICURE**

Set manicure HUGO BOSS realizzato in poliuretano morbido, granulato. Contiene 7 pezzi in acciaio stainless steel: lime per unghie, forbici, pinzette, tagliaunghie, pulitore orecchie, smacchiatore per cuticole e forchetta per la pelle.

HUGO BOSS

-  Poliuretano
-  12x9x2,5 cm.
-  1



**AB 0401
PARURE PENNA
PORTACHIAVI**

Parure penna e portachiavi HUGO BOSS in pelle gofrata con particolari in acciaio inossidabile. Confezione in astuccio.

HUGO BOSS



-  Pelle
-  3,2 x 3 x 8 cm
-  1



**AB 0407
PORTACHIAVI**

Portachiavi HUGO BOSS in acciaio inossidabile laccato. Confezione in astuccio.

HUGO BOSS

-  Acciaio
-  Ø 5 cm
-  1



AB 0408
AGENDA
PERPETUA A5

Agenda in poliuretano con texture nera a grana morbida e dettagli in cromato lucido. Chiusura con elastico.

HUGO BOSS



Poliuretano



21,3 x 15,3 x 1,4 cm.



1

AB 0409
AGENDA
PERPETUA A6

Agenda in poliuretano con texture nera a grana morbida e dettagli in cromato lucido. Chiusura con elastico.

HUGO BOSS



Poliuretano



15 x 11 x 1,4 cm.



1



AB 0410
CARTELLA A4

Cartella portablocco HUGO BOSS in similpelle morbido, doppia tasca con chiusura a zip, blocco note incluso. Confezione in astuccio.

HUGO BOSS



Similpelle



31 x 23,6 x 3,5 cm



1





AB 0400 CARTELLA A5

Cartella A5 HUGO BOSS in pelle gofrata, con manico e con chiusura a zip. Interno con blocco note A5 e varie tasche portacard. Confezione in astuccio.

HUGO BOSS



Pelle



24,3 x 19,5 x 3 cm



1



**AB 0430
OMBRELLO**

Ombrello pieghevole HUGO BOSS con apertura automatica.



Poliestere



Ø 100 x H 64 cm



1

**AB 0431
OMBRELLO**

Ombrello HUGO BOSS in poliestere con manico curvo con apertura automatica.



Poliestere



Ø 112 x H 92 cm



1

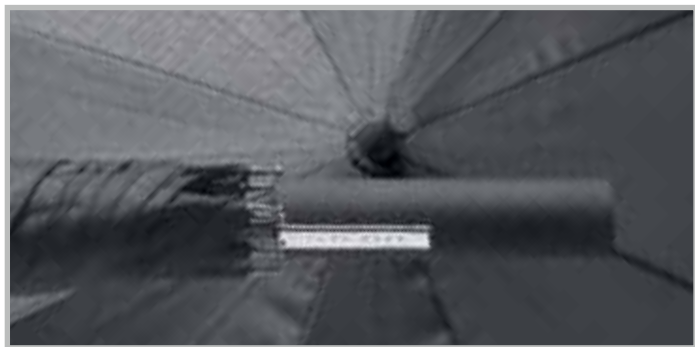

**AB 0434
OMBRELLO**

Ombrello pieghevole HUGO BOSS in poliestere con apertura automatica.



Poliestere



Ø 104 x H 60 cm



1

**AB 0433
OMBRELLO**

Ombrello golf HUGO BOSS in poliestere e fibra di vetro con apertura automatica.



Poliestere





Ø 130 x H 100 cm



1

**AB 0672
PORTACHIAVI
CON USB**

Il portachiavi con USB 16 GB della collezione "Hamilton" di CERRUTI 1881 è una grande idea regalo allo stesso tempo elegante e funzionale. Realizzato in pelle nei colori nero, blu scuro, tortora, stampato a grana e particolari in metallo cromato, viene confezionato in box CERRUTI 1881.



-  Pelle
-  23,5 x 21 x 9 cm
-  1

CERRUTI 1881



**AB 0667
FERMASOLDI**

In acciaio stainless steel con un logo Cerruti delicatamente impresso sulla superficie lucida e 1881 tagliato al laser.

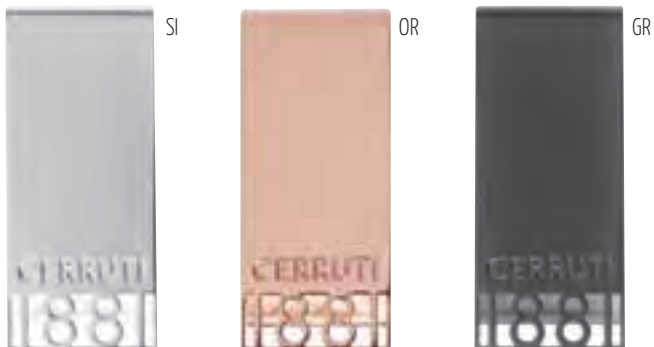

-  Acciaio
-  3,8 x 3,4 cm
-  1

CERRUTI 1881



**AB 0671
PORTACHIAVI**

Portachiavi realizzato in una pelle nera liscia accuratamente selezionata, fissata ad una struttura cromata lucida con due anelli metallici.

-  Pelle
-  14 x 2 cm
-  1

CERRUTI 1881



**AB 0678
PORTACARD**

Chiusura con zip, realizzato in pelle nera liscia accuratamente selezionata.



Pelle



11,3 x 9 cm



1

CERRUTI 1881



**AB 0679
PORTACARD**

Chiusura con zip, realizzato in pelle nera liscia accuratamente selezionata.



Pelle



13 x 7 cm



1

CERRUTI 1881



**AB 0676
PORTAFOGLI DA
UOMO**

Il portafoglio CERRUTI 1881 della collezione "Hamilton" è realizzato in pelle di alta qualità, stampato a grana. La pelle ha una finitura opaca, che gli conferisce un aspetto molto moderno. Il logo CRR è cromato, per un look che è sia alla moda che classico. Il portafoglio è dotato di porta monete e 4 porta card. Confezionato in scatola regalo CERRUTI 1881.



Pelle



11,6 x 9,7 x 1,3 cm



1

CERRUTI 1881



AB 0645 BEAUTY

Un perfetto accessorio da viaggio della collezione "Hamilton" di CERRUTI 1881. Questo morbido e capiente beauty è stato realizzato in ecopelle stampata a grana e rifinito internamente con un lining in nylon. Le finiture in metallo cromato donano un ulteriore tocco di eleganza. Confezionato in sacca in TNT personalizzata CERRUTI 1881.



Similpelle



25 x 14 x 15 cm



1

CERRUTI 1881



AB 0650 TRACOLLA

Tracolla Hamilton di Cerruti 1881 realizzata in similpelle nera, chiusura con zip a doppio cursore, tasca esterna con zip, cinturino regolabile e amovibile.



Similpelle



26 x 21 x 5 cm



1

CERRUTI 1881



**AB 0498
FOULARD**

Foulard UNGARO in pura seta. Confezione in astuccio.

ungaro



Seta



90 x 90 cm



1



**AB 0505
BEAUTY**

Beauty in poliuretano, con due scomparti a doppia cerniera colorata.

ungaro



Poliuretano



16 x 7,5 x 10 cm



1



**AB 0506
PORTAFOGLI**

E' realizzato in pelle scamosciata, impressa da un motivo ispirato al coccodrillo. La targhetta in metallo è in colore rosegold, dotato di 7 slot per schede su ogni lato, oltre a scomparti più grandi per appunti e documenti. Ha anche un grande scomparto con cerniera.

ungaro



Pelle



19 x 9,7 x 2 cm



1



AB 0531 OROLOGIO DA UOMO

Orologio da polso uomo Ungaro, cinturino in pelle scamosciata, cassa in acciaio, meccanismo Seiko VX36, resistenza all'acqua 3 atm. Confezione in astuccio.



Lega di Zinco/Pelle



Dim quadr. Ø 4,4 cm
Lungh. 26,5 cm



1

ungaro



GRANDI FIRME



NE



MA



BL

AB 0538 OROLOGIO DA UOMO

Cronografo con lussuosa cassa in acciaio inossidabile, placcato in nero. Il cinturino è realizzato in pelli pregiate e accuratamente selezionate, con finitura in pelle scamosciata. Meccanismo Myota JS 20, resistenza all'acqua 10 ATM.



Acciaio/Pelle



Dim quadr. Ø 4,2 cm
Lungh. 26 cm



1

ungaro



BL



NE



**AB 0794
FOULARD**

Foulard realizzato in morbida e leggera lana impreziosita da una vibrante stampa a farfalla di colore blu scuro e giallo. Confezione in astuccio.



Lana



90 x 90 cm



1

cacharel



**AB 0783
BORSA**

La borsa "Madeleine" è femminile e funzionale. in poliuretano con intelligente sistema di maniglie adattabile che permette di portarla in mano o sulla spalla. La sua forma flessibile e i numerosi scomparti la rendono facile da organizzare.



Poliuretano



34,5 x 16,2 x 20 cm



1

cacharel



BL



**AB 0793
FOULARD**

Foulard realizzato in finissima seta.
Confezione in astuccio.



Seta



90x90 cm



1

cacharel

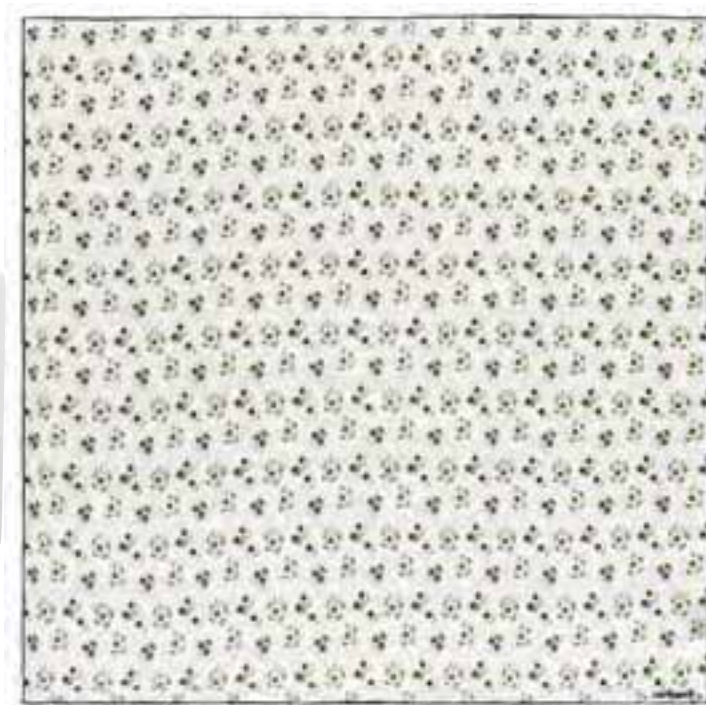

**AB 0783
BORSA**

La borsa "Madeleine" è femminile e funzionale, in poliuretano con intelligente sistema di maniglie adattabile che permette di portarla in mano o sulla spalla. La sua forma flessibile e i numerosi scomparti la rendono facile da organizzare.



Poliuretano



34,5 x 16,2 x 20 cm



1

cacharel



BG



**AB 0788
BORSA**

La piccola borsa CACHAREL realizzata in materiale poliuretano granulare di Saffiano. Può essere portata a mano o a spalla grazie alla tracolla regolabile e rimovibile. La sua firma metallica e la fodera in colore contrastante gli conferiscono un tocco unico e originale.



Poliuretano



23,5 x 17,5 x 11,5 cm



1

cacharel

LV



BL

**AB 0798
OCCHIALI DA SOLE**

Gli occhiali da sole CACHAREL con forma arrotondata per un look retrò, ornate da dettagli in metallo dorato. Dotati di una buona protezione solare, garantiscono un comfort visivo ideale. Dotati di custodia rigida e scatola di cartoncino Cacharel.



Plastica/policarbonato



18 cm



1

cacharel

NE

RS

**AB 0799
OROLOGIO DA DONNA**

Un orologio dal design vivace e colorato CACHAREL. Il quadrante, arricchito con pietre colorate, rende questo accessorio un classico con forte personalità. Cinturino in pelle. Confezionato in elegante box CACHAREL.



Lega Zinco/pelle

Dim quadr. Ø 3,4 cm
Lungh. 23,5 cm

1



cacharel

NE

RS

**AB 0787
BORSA**

Borsa donna CACHAREL realizzata in materiale poliuretano a grana in doppia tonalità. Dotata di una ampia tasca interna estraibile e utilizzabile come custodia per cosmetici o come piccola borsa grazie alla tracolla rimovibile.



-  Poliuretano
-  28 x 28 x 16,5 cm
-  1

cacharel



**AB 0789
BORSA**

Borsa in poliuretano gioca con sottile contrasto tra le texture. La chiusura placcata oro chiaro, con il logo del marchio in rilievo, è lussuosa e femminile.

-  Poliuretano
-  19,8 x 13,5 x 3,5 cm
-  1

cacharel





AB 0494 PROFUMATORE AMBIENTE

50 ml Bouquet de Provence. Un profumatore con bastoncini in legno realizzato con essenze provenzali e presentato nell'elegante flacone "carré" da 50 ml. Fragranze Spezie d'Oriente (01) - Vaniglia e Patchouli (03)- Legno di Cedro e Lime (05) - Seta Pura e Legni (07). Confezionato in box regalo.

BOUQUET DE PROVENCE
1878
Maison de Parfum



	Vetro e Legno
	4,5 x 8 cm
	1



**AB 0439
PROFUMATORE
AMBIENTE**



Assortito nelle fragranze Frisson - Voyager
- Coucher - Printemps. Confezionato in box
regalo. 200 ml.

VERY

-  Vetro e Legno
-  12 X 7 cm
-  1

**AB 0450
CRYSTAL BEAUTY**

Realizzato in TPU, un materiale morbidissimo e trasparente con finiture in ottone dorato, confezionato con fascia dorata LAVILLE.

-  TPU
-  21 x 10 x 7 cm
-  1

LAVILLE PARIS



**AB 0452
SPECCHIETTO**

Specchietto in ecopelle con charms e doppio specchietto. Confezione in scatola regalo.

-  Ecopelle
-  Ø 8 cm
-  1

LAVILLE PARIS



VE



BI



AZ

AB 0460 SCIARPA

Lasciatevi conquistare dal calore avvolgente della sciarpa imbottita firmata Laville. La nuance si abbina a tutta la palette di stagione e aggiunge un tocco moderno alle vostre mise. Confezionata in sacchetto con chiusura a zip.



Poliestere



85 x 11 cm



1

BI

LAVILLE PARIS



GR



BG



AB 0458 PROFUMATORE 50 ML

Creato con l'utilizzo di fragranze francesi, contenuto in flacone di vetro con bastoncini in legno. Confezione in box regalo LAVILLE.



Vetro e legno



8 x 4,5 cm



1

LAVILLE PARIS





AB 0469 SET VIAGGIO 3 PZ

Un pratico tris viaggio, realizzato in polycotton two tone di colore grigio. Arricchito dalla stampa "Vintage" di LAVILLE PARIS. Il set è composto da:

- BORSONE con chiusura a cerniera e manici imbottiti.
- SACCA con chiusura a coulisse in corda e dotata di cinghia porta spalla.
- BEAUTY TERMICO con chiusura a cerniera.

LAVILLE PARIS



Polycotton



Borsone : 49 x 34 x 20 cm

Sacca: 50 x 30 cm

Beauty: 22,5 x 14 x 15 cm



1



AB 0472 SET VIAGGIO

Set composto da borsone e beauty con chiusura a zip, realizzato in polycotton ecru, arricchito con ricamo stile "vintage" di LAVILLE PARIS.

LAVILLE PARIS



Polycotton



Borsone: 49 x 34 x 20 cm
Beauty: 27 x 9 x 21 cm



1



AB 0485 TROLLEY

Bagaglio a mano in cotone delavè, conforme agli standard delle maggiori compagnie aeree. Dotato di 2 maniglie in ecopelle imbottite e 2 compartimenti con chiusura a cerniera a doppio cursore. Carrello telescopico monotubo in alluminio con tasca a scomparsa. Interno foderato con stampa "all over" del monogramma LAVILLE. Fondo rigido e retro rinforzato con piedini.

LAVILLE PARIS



Cotone Delavè



52 x 35 x 20 cm

Peso: 1,45 kg

Capacità: 42 litri



1

AB 0486 MAXI BORSONE

Maxi borsone in cotone delavè con manici e particolari in ecopelle, interno con due tasche aperte ed una con chiusura a zip. Finiture in metallo nel colore canna di fucile. Tracolla regolabile. Ricamo marchio LAVILLE Paris vintage.



Cotone/Ecopelle



28 x 52 x 32 cm



1

LAVILLE PARIS



AB 0487 BORSONE

Borsone in cotone delavè con finiture in ecopelle, chiusura a cerniera, due tasche esterne con chiusura a velcro. Ricamo marchio LAVILLE Paris vintage.



Cotone/Ecopelle



28 x 48 x 22 cm



1

LAVILLE PARIS



AB 0479**SACCA**

Sacca in cotone dèlavè ed ecopelle, passanti in metallo con finitura canna di fucile, cinghia porta spalla, ricamo vintage del marchio LAVILLE PARIS.



Cotone / Ecopelle



50 x Ø 30 cm



1

LAVILLE PARIS**AB 0481****ZAINO**

Zaino in cotone dèlavè ed ecopelle, doppio scomparto con chiusura a zip, tasca porta computer, spallacci regolabili, retro imbottito, ricamo vintage del marchio LAVILLE PARIS.



Cotone / Ecopelle



45 x 30 x 8 cm



1

LAVILLE PARIS

AB 0477 BORSONE

In cotone délavè ed ecopelle, finiture in metallo canna di fucile, tracolla e manici in ecopelle, tasca interna con chiusura a zip, ricamo vintage del marchio LAVILLE PARIS.



Cotone / Ecopelle



41 x 41 x 22 cm



1

LAVILLE PARIS



AB 0478 BEAUTY

Beauty in cotone délavè ed ecopelle, manico in ecopelle, ricamo vintage del marchio LAVILLE PARIS.



Cotone / Ecopelle



27 x 21 x 9 cm



1

LAVILLE PARIS



AB 0484 TRACOLLA

Tracolla in cotone délavè, unico scomparto con chiusura a zip, tasca frontale aperta, tasca porta documenti sul retro con chiusura a zip, tracolla in ecopelle regolabile. Ricamo marchio LAVILLE Paris vintage.



Cotone / Ecopelle



24 x 24 x 6 cm



1



LAVILLE PARIS





AB 0480 PALLINA DI NATALE

Per un Natale scintillante e luminoso! Una collezione di palle con decorazioni natalizie realizzato in Poli-Crystal trasparente che si illuminano rendendo magica l'atmosfera della vostra casa. Disponibile in 3 varianti assortite. Confezionate in scatola regalo

-  Poli-Crystal
-  Ø 8,5 cm
-  1

LAVILLE PARIS



AB 0489 PORTACANDELE

LAVILLE PARIS ha creato questa collezione di portacandele in vetro sabbato che, al loro interno, hanno una speciale lamina in argento 925/1000 che permette alla candela di riflettere la luce. La collezione è composta da 4 modelli nei colori: bianco, argento, oro e ramato. Un accessorio per la vostra tavola.

-  Vetro Sabbato
-  Ø 10 cm
-  1

LAVILLE PARIS

**AB 0473
PORTACARD**

In ecopelle nera. Confezionato in scatola di cartoncino Laville Paris.

LAVILLE PARIS



Ecopelle



10 x 7,5 cm



1



**AB 0483
PORTACHIAVI VESPA**

Portachiavi in metallo nelle varianti cromo, oro e oro rosa. Confezionato in Gift box.

LAVILLE PARIS



Metallo



5X5 cm





1



AB 0852 BORSA DA VIAGGIO ELEMENT

Super leggera realizzata in morbido poliuretano nero opaco e in nylon blu scuro molto liscio e delicato. L'etichetta in gomma stampata con il logo Christian Lacroix delicatamente cucito sul nylon dà un tocco giovane e casual.

Christian Lacroix



-  Poliuretano e Nylon
-  51 x 25 x 28 cm
-  1



AB 0853 ZAINO ELEMENT

Super leggero realizzato in morbido poliuretano nero opaco e in nylon blu scuro molto liscio e delicato. Custodia interna portcomputer e tasca con zip sul retro. L'etichetta in gomma stampata con il logo Christian Lacroix delicatamente cucito sul nylon dà un tocco giovane e casual.



Christian Lacroix

-  Poliuretano e Nylon
-  27 x 15 x 11 cm
-  1

AB 0854 BEAUTY

Beauty realizzato in poliuretano e nylon , chiusura con zip.

Christian Lacroix

-  Poliuretano e Nylon
-  27 x 15 x 11 cm
-  1



promosolution2020|2021

**TROLLEY
BORSE DA VIAGGIO
ZAINI PORTA PC
VALIGIE
TRACOLLE**



new!

sistema brevettato di ruota a scomparsa

SI



BL



- 1 Tira la leva rossa e apri lo sportellino
- 2 Estrai la ruota fino al "clic"
- 3 Chiudi lo sportellino
- 4 Parti con più spazio in cabina!

**AC 1394
TROLLEY CABINA**

In abs con struttura light, dotato di 4 ruote doppie ABS girevoli a 360 gradi con sistema brevettato di ruote a scomparsa che consente di recuperare spazio in cabina, zip a doppio cursore, chiusura TSA integrata.



ABS



Dim. 55x40x20 cm
(con ruote interne)

Vol.: 50 lt
Peso: 2,4 kg



1



**AC 1396
TROLLEY CABINA**

In policarbonato con struttura light, dotato di 4 ruote doppie ABS girevoli a 360 gradi, zip a doppio cursore, chiusura TSA integrata.

CERRUTI 1881



Policarbonato



Dim. 54x34x20 cm

Vol.: 38 lt

Peso: 2,9 kg







1



**AC 1398
TROLLEY CABINA**

In abs con struttura light, dotato di 4 ruote doppie ABS girevoli a 360 gradi, zip a doppio cursore, chiusura TSA integrata.



-  ABS
-  Dim. 55x38x20 cm (con ruote interne)
-  Vol.: 40 lt
-  Peso: 2,6 kg
-  1



**AC 1416
TROLLEY**

In ABS con struttura super light, 4 ruote girevoli con cuscinetti.



ABS



Dim. 68x42x27 cm

Vol.: 80 lt

Peso: 3,5 kg



1





TU



TU



TU



BL



BL



BL

AC 1400 TROLLEY GRANDE





In polipropilene con struttura light, dotato di 4 ruote doppie ABS girevoli a 360 gradi, zip a doppio cursore, chiusura TSA integrata.

-  Polipropilene
-  Dim.: 75x52x29 cm
-  Vol.: 110 lt
-  Peso: 4,1 kg
-  1



AC 1401 TROLLEY MEDIO





In polipropilene con struttura light, dotato di 4 ruote doppie ABS girevoli a 360 gradi, zip a doppio cursore, chiusura TSA integrata.

-  Polipropilene
-  Dim.: 65x45x25 cm
-  Vol.: 80 lt
-  Peso: 3,4 kg
-  1



AC 1402 TROLLEY CABINA

In polipropilene con struttura light, dotato di 4 ruote doppie ABS girevoli a 360 gradi, zip a doppio cursore, chiusura TSA integrata.

-  Polipropilene
-  Dim.: 55x37x20 cm
-  Vol.: 40 lt
-  Peso 2,100 kg
-  1



NE



NE



NE



BL



BL



BL



**AC 1448
TROLLEY GRANDE**

In poliestere 600D "two tone" con struttura super light, tsa integrato, 4 ruote girevoli con cuscinetti, chiusura con zip a doppio cursore, due tasche esterne con zip.

-  Poliestere
-  Dim. 78x47x30/35 cm
-  Vol.: 105/125 lt
-  Peso: 3,7 kg
-  1



**AC 1449
TROLLEY MEDIO**

In poliestere 600D "two tone" con struttura super light, tsa integrato, 4 ruote girevoli con cuscinetti, chiusura con zip a doppio cursore, due tasche esterne con zip.

-  Poliestere
-  Dim. 68x42x28/32 cm
-  Vol.: 80/95 lt
-  Peso: 2,9kg
-  1



**AC 1450
TROLLEY CABINA**

In poliestere 600D "two tone" con struttura super light, tsa integrato, 4 ruote girevoli con cuscinetti, chiusura con zip a doppio cursore, due tasche esterne con zip.

-  Poliestere
-  Dim. 53x38x20 cm
-  Vol.: 40 lt
-  Peso: 2,3 kg
-  1





VE



VE



BL

AC 1406 TROLLEY MEDIO

in poliestere espandibile con interno foderato, dotato di 4 ruote ABS girevoli a 360 gradi, zip a doppio cursore, chiusura TSA integrata.



Poliestere



Dim: 68x42x28/32 cm

Vol: 80/95 lt

Peso 2,9 kg



1

AC 1407 TROLLEY CABINA

in poliestere espandibile con interno foderato, dotato di 4 ruote ABS girevoli a 360 gradi, zip a doppio cursore, chiusura TSA integrata.



Poliestere



Dim: 53x38x20 cm

Vol.: 40 lt

Peso: 2,3 kg



1



AC 1451 BORSA DA VIAGGIO CON TROLLEY

In poliestere 600D "two tone" con struttura super light, 2 ruote, chiusura con zip a doppio cursore, due tasche esterne con zip, tracolla rimovibile e asportabile.



Poliestere 600D



Dim. 65x38x35 cm

Vol.: 80 lt

Peso: 2,0 kg



1



AC 1493 TRACOLLA PORTATABLET

In poliestere 600D "two tone", chiusura con zip, tasca esterna con zip, tracolla regolabile.



Poliestere 600D



22x20x7 cm



1



AC 1492 MARSUPIO

In poliestere 600D "two tone", chiusura con zip a doppio cursore, tre tasche esterne con zip, cinghia regolabile.



Poliestere 600D



20/33x13x18 cm



1





JAGUAR



**AC 1432
TROLLEY CABINA
PORTA COMPUTER E
ABITI 48 ORE**

In poliestere 1680 D, impermeabile e antistrappo, con struttura super light, 2 ruote con cuscinetti a sfera, chiusura con zip a doppio cursore, tascone esterno richiudibile con zip.



Poliestere



Dim. 38x50x20 cm

Vol.: 40 lt

Peso: 2,3 kg



1

JAGUAR



**AC 1431
ZAINO
TROLLEY
CABINA**

In poliestere, con struttura super light, 2 ruote, chiusura con zip a doppio cursore, spallacci imbottiti a scomparsa, tascone esterno richiudibile con zip.



Poliestere



Dim. 55x36x21 cm

Vol.: 44 lt



1



AC 1483
ZAINO
TROLLEY
CABINA

In poliestere, con struttura super light, 2 ruote, chiusura con zip a doppio cursore, dotato di porta usb esterna con cavo interno, spallacci imbottiti a scomparsa, tascone esterno richiudibile con zip.

CERRUTI 1881



Poliestere



50x35x27 cm



1

**AC 1481
ZAINO PORTA
COMPUTER
E TABLET**

In poliestere "two tone". Cerniere lampo impermeabili, tasca frontale organizzata, spallacci regolabili.



Poliestere 600D



24x29x8 cm



1



**AC 1482
ZAINO PORTA
COMPUTER
E TABLET**

In poliestere "two tone", tasca frontale organizzata, spallacci regolabili.



Poliestere 600D



24x29x8 cm



1



promosolution 2020|2021

**AGENDE IN PELLE
AGENDE IN SIMILPELLE
AGENDE BLOCCO FISSO
AGENDE IN VIVELLA
AGENDINE TASCABILI
PLANNING CON SPIRALE**



NE





MA



**AD 1524
AGENDA IN PELLE**

Agenda portafoglio in pelle fiore con interno giornaliero intercambiabile in carta avorio sabato e domenica separati. Chiusura con linguetta e bottone, tasche interne portacard. Corredata di astuccio.



-  Pelle
-  17 x 24 cm
-  1/10



**AD 1525
AGENDA IN PELLE**

Agenda portafoglio in pelle fiore con interno giornaliero intercambiabile in carta avorio sabato e domenica separati rivestito in vivella Chiusura con linguetta e bottone, tasche interne portacard. Ampia tasca esterna. Corredata di astuccio.



Pelle



17 x 24 cm



1/10

BL



NE





INTERNO GIORNALIERO



**AD 1523
AGENDA**

Agenda portafoglio in coagulato termovirante con interno giornaliero intercambiabile in carta avorio sabato e domenica separati rivestito in vivella. Chiusura con linguetta e bottone, tasche interne portacard. Corredata di astuccio.



-  Coagulato
-  17 x 24 cm
-  1/10

AD 1526 AGENDA

Agenda portafoglio in coagulato termovirante con interno giornaliero intercambiabile in carta avorio **sabato e domenica separati** rivestito in vivella. Chiusura con linguetta e bottone, tasche interne portacard. Corredata di astuccio.



Coagulato



15 x 21 cm



1/20



AD 1527 AGENDA BORSELLO

Agenda Borsello in coagulato termovirante con interno giornaliero intercambiabile in carta avorio **sabato e domenica separati** rivestito in vivella. Chiusura con zip, tasche interne portacard. Corredata di astuccio.



Coagulato



17 x 24 cm





1/20



**AD 1528
AGENDA**



Agenda portafoglio in coagulato termovirante con interno giornaliero intercambiabile in carta avorio sabato e domenica separati rivestito in vivella . Chiusura con linguetta e bottone, tasche interne portacard. Corredata di astuccio.

-  Coagulato
-  17 x 24 cm
-  1/20



**AD 1529
AGENDA**

Agenda portafoglio coagulato termovirante con interno giornaliero intercambiabile in carta avorio sabato e domenica separati rivestito in vivella . Chiusura con linguetta e bottone, tasche interne portacard. Corredata di astuccio.

-  Coagulato
-  15 x 21 cm
-  1/20





BL



TO



**AD 1530
AGENDA BORSELLO**

Agenda borsello coagulato termovirante con interno giornaliero intercambiabile in carta avorio sabato e domenica separati rivestito in vivella . Chiusura con zip, tasche interne portacard. Corredata di astuccio.



Coagulato





17 x 24 cm



1/20

**AD 1531
AGENDA**



Agenda portafoglio in coagulato termovirante con interno giornaliero intercambiabile in carta avorio sabato e domenica separati rivestito in vivella . Chiusura con linguetta e bottone, tasche interne portacard. Corredata di astuccio.

-  Coagulato
-  17 x 24 cm
-  1/20



**AD 1532
AGENDA**

Agenda portafoglio in coagulato termovirante con interno giornaliero intercambiabile in carta avorio sabato e domenica separati rivestito in vivella . Chiusura con linguetta e bottone, tasche interne portacard. Corredata di astuccio.

-  Coagulato
-  15 x 21 cm
-  1/20







**AD 1533
AGENDA**

Agenda portafoglio in coagulato termovirante con interno giornaliero intercambiabile in carta avorio sabato e domenica separati rivestito in vivella. Chiusura con linguetta e bottone. Corredata di astuccio.



-  Coagulato
-  15 x 21 cm
-  1/20



**AD 1545
AGENDA BORSELLO**

Agenda giornaliera a borsello con copertina in materiale toscana termovirante. Chiusura con zip. Interno mobile, **sabato e domenica separati** in carta avorio da 448 pagine di cui 52 pagine di riepilogo settimanale. Rubrica estraibile. Confezione in astuccio.



Toscana Termovirante



17 x 24 cm



1/30



**AD 1546
AGENDA PORTAFOGLIO**

Agenda giornaliera a portafoglio con copertina in materiale toscana termovirante. Interno sabato e domenica separati in carta bianca da 448 pagine di cui 52 pagine di riepilogo settimanale. Rubrica estraibile. Confezione in astuccio.



Toscana Termovirante



17 x 24 cm



1/30

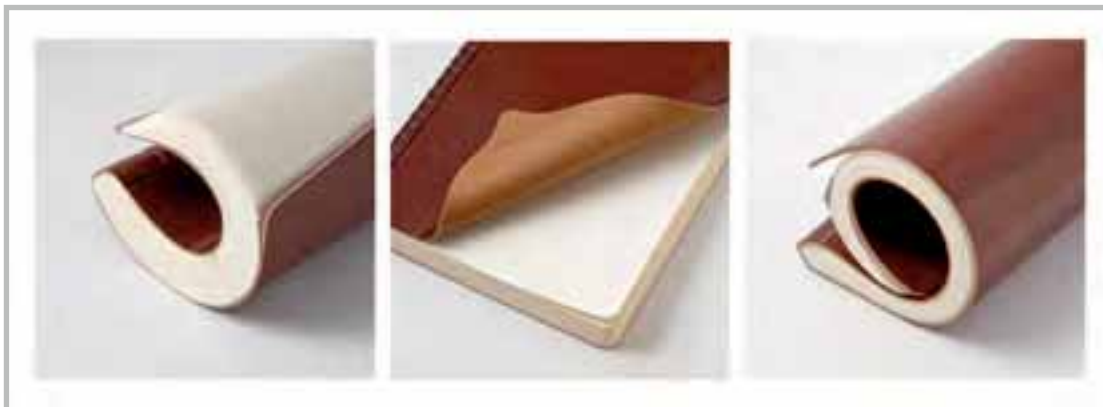

**AD 1540
AGENDA GIORNALIERA**

Agenda giornaliera a blocco fisso in bimatereale toscana abbinato a vivella termovirante. Interno in carta bianca **sabato e domenica separati** da 448 pagine compreso rubrica estraibile e 52 pagine di riepilogo settimanale. Confezione in astuccio.



Vivella Termovirante



17 x 24 cm



1/24

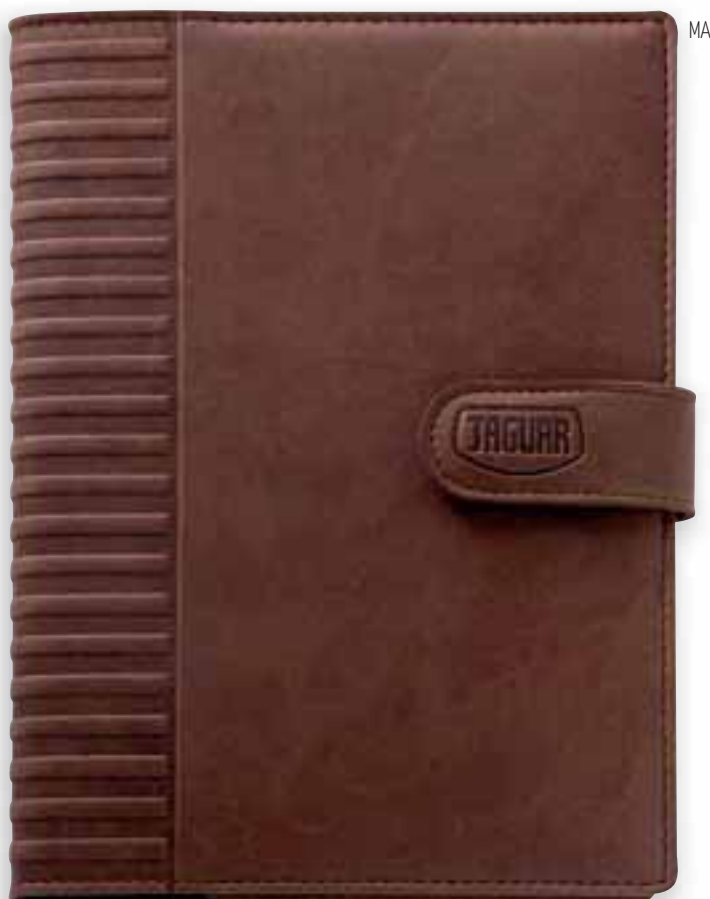

MA



BL



NE



AR

AD 1600 AGENDA GIORNALIERA

Agenda giornaliera a portafoglio con copertina in materiale vivella Termovirante, linguetta di chiusura con bottone con taglio portapenna, interno mobile giornaliero sabato e domenica separati in carta avorio. Astuccio incluso.



Vivella Termovirante



15 x 21 cm



1/10

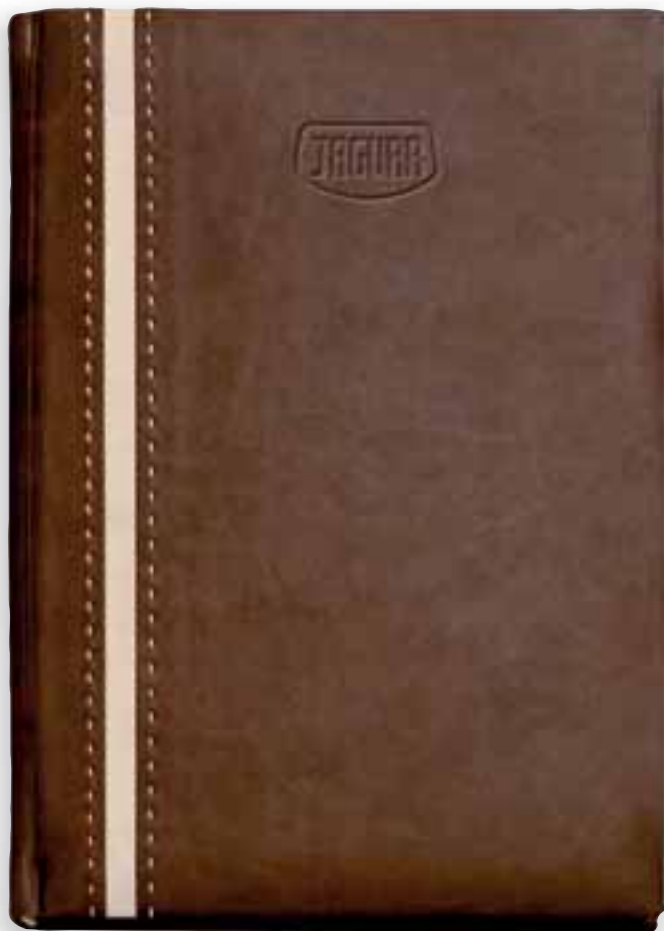

**AD 1534
AGENDA GIORNALIERA**

Agenda giornaliera a blocco fisso in vivella termovirante marrone e beige. Interno **sabato e domenica separati** carta bianca da 448 pagine compresa rubrica fustellata estraibile e 52 pagine di riepilogo settimanale. Confezione in astuccio.



Vivella Termovirante



17 x 24 cm



1/18

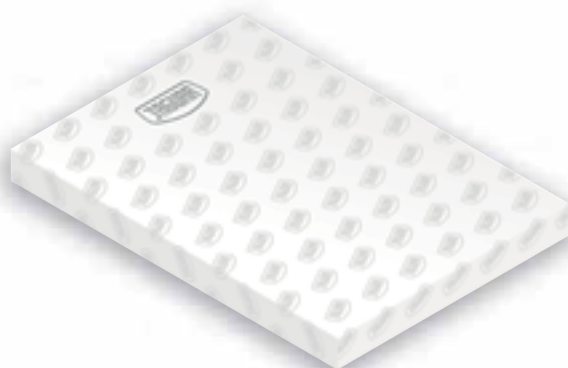

AD 1535 AGENDA GIORNALIERA

Agenda giornaliera a blocco fisso in vivella termovirante marrone e beige. Interno **sabato e domenica separati** carta bianca da 448 pagine compresa rubrica fustellata estraibile e 52 pagine di riepilogo settimanale. Confezione in astuccio.



Vivella Termovirante



17 x 24 cm



1/18



**AD 1625
AGENDA
GIORNALIERA**

Copertina in Vivella adatta per la stampa a caldo. Interno Multilingue carta bianca, **sabato e domenica separati**. Rubrica telefonica, cartina geografica.



Vivella Termovirante



15x21 cm



1/20

**AD 1633
ASTUCCIO**

Astuccio In Cartoncino



Cartoncino



15 x 21 cm





RO

RY



AGENDE

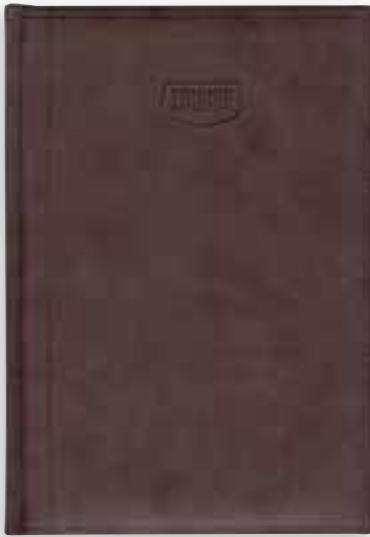

MA

BL



BG

VE



**AD 1625
AGENDA
GIORNALIERA**

Copertina in Vivella adatta per la stampa a caldo. Interno Multilingue carta bianca, **sabato e domenica separati**. Rubrica telefonica, cartina geografica.



Vivella
Termovirante



15 x 21 cm



1/20



RO



BL



GR



RY



**AD 1601
AGENDA GIORNALIERA**

Agenda giornaliera a portafoglio con copertina in materiale vivella termovirante bicolore, linguetta di chiusura con bottone con taglio portapenna (penna esclusa), interno mobile giornaliero sabato e domenica separati in carta bianca. Astuccio incluso.



Vivella Termovirante



15 x 21 cm



1/10



VE



TO



MA



**AD 1605
AGENDA GIORNALIERA CON
ELASTICO**

Agenda giornaliera a blocco fisso in bimatereale toscana abbinato a vivella termovirante. Chiusura con elastico. Passante esterno portapenna (penna esclusa). Interno in carta bianca **sabato e domenica separati**. Confezione in astuccio.



Vivella Termovirante



15 x 21 cm



1/18

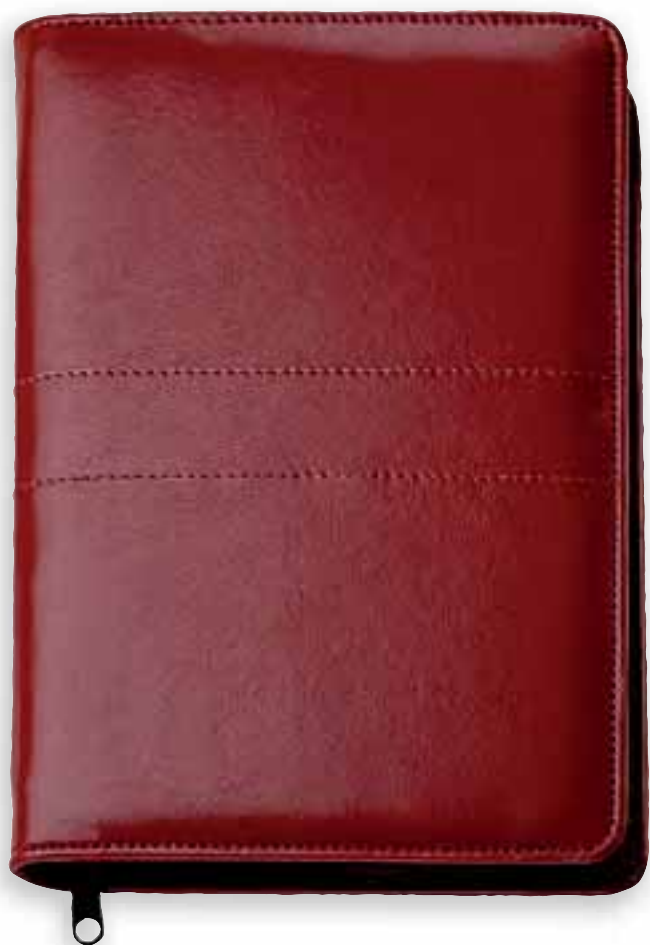

B0



NE



BL



**AD 1590
AGENDA**

Agenda borsello in coagulato termovirante, chiusura con zip, tasca interna porta documenti richiudibile con bottone con vari scomparti porta carte di credito. Interno mobile giornaliero in carta bianca **sabato e domenica separati**. Confezione in astuccio.



Coagulato Termovirante



17 x 24 cm





1/30



**AD 1551
AGENDA**

Agenda portafoglio in coagulato termovirante, chiusura con linguetta e bottone, vari scomparti interni porta carte di credito. Interno mobile giornaliero in carta bianca **sabato e domenica separati**. Confezione in astuccio.

-  Coagulato Termovirante
-  17 x 24 cm
-  1/30



BL



NE



AR



RO



TO



GI

AD 1583 AGENDA

Agenda portafoglio in coagulato termovirante, pattina esterna con chiusura a bottoni e tasca con zip, vari scomparti interni porta carte di credito e porta documenti. Interno mobile giornaliero in carta bianca **sabato e domenica separati**. Confezione in astuccio.



Coagulato Termovirante



15 x 21 cm





1/30

GR



**AD 1582
AGENDA**

Agenda in coagulato termovirante con elastico di chiusura dotato di vano portapenna (penna non inclusa). Interno mobile giornaliero in carta bianca **sabato e domenica separati**. Confezione in astuccio.

-  Coagulato Termovirante
-  15 x 21 cm
-  1/30



RO



AR



BI



BO



NE



**AD 1598
AGENDA**

Agenda in coagulato termovirante, chiusura con linguetta e bottone. Interno mobile giornaliero in carta bianca **sabato e domenica separati**. Confezione in astuccio.



Coagulato Termovirante



15 x 21 cm



1/30



RO



MA

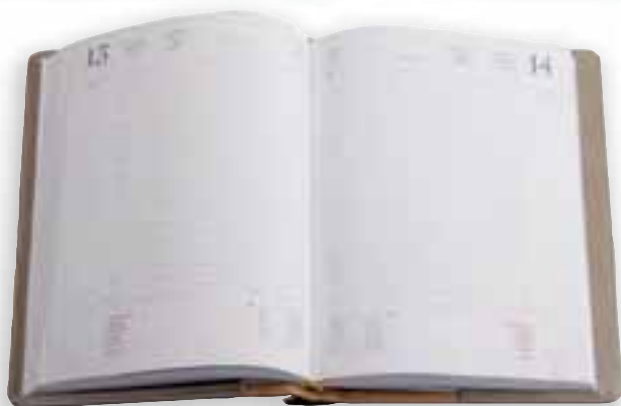

**AD 1581
AGENDA**

Agenda in coagulato termovirante con vano portapenna sul dorso (penna non inclusa). Interno mobile giornaliero in carta bianca **sabato e domenica separati**. Confezione in astuccio.



Coagulato Termovirante



15 x 21 cm



1/30



AR



RO



BL



TU



BI



**AD 1595
AGENDA**

Agenda in coagulato termovirante. Interno mobile giornaliero in carta bianca **sabato e domenica separati**. Confezione in astuccio.



Coagulato Termovirante



15 x 21 cm



1/30



RO



AR



**AD 1597
AGENDA**

Agenda borsello in coagulato termovirante, chiusura con zip, vari scomparti interni porta carte di credito e porta documenti. Interno mobile giornaliero in carta bianca **sabato e domenica separati**. Confezione in astuccio.

 Coagulato Termovirante

 15 x 21 cm

 1/25



BI



AZ



AR



BO



RO



NE



GR



BL



VE



RY



**AD 1627
AGENDA**

Agenda giornaliera in matra. Interno multilingue, stampa 2 colori, carta bianca, sabato e domenica abbinati. Rubrica telefonica, cartina geografica. Festività internazionali.



Matra



15 x 21 cm



1/20



BI



AZ



AR



BO



RO



NE



GR



BL



VE



RY



AD 1624 AGENDA

Mini agenda giornaliera in matra. Interno multilingue, stampa 2 colori, carta bianca, sabato e domenica abbinati. Rubrica telefonica, cartina geografica. Festività internazionali.



Matra



11 x 17 cm



1/20



RO



GR



BL



VE



BO



NE



RY



**AD 1630
AGENDA SETTIMANALE**

Agenda settimanale in matra. Interno multilingue, stampa 2 colori, carta bianca, sabato e domenica abbinati. Rubrica telefonica, cartina geografica. Festività internazionali.



Matra



17 x 24 cm



1/30



BL



RO



GR



RY



VE



BO





NE



AD 1620 AGENDA GIORNALIERA

Agenda giornaliera in matra. Interno multilingue, stampa 2 colori, carta bianca, sabato e domenica abbinati. Rubrica telefonica, cartina geografica. Festività internazionali.





-  Matra
-  17 x 24 cm
-  1/20



**AD 1613
MAXI AGENDA GIORNALIERA
RISTORANTE**

Agenda in matra. Interno multilingue, stampa 2 colori, carta bianca, **venerdì sabato e domenica con doppia pagina**. Rubrica telefonica, cartina geografica. Festività internazionali. Pagine perforate.





-  Matra
-  21 x 30 cm
-  1/14



**AD 1614
MAXI AGENDA
GIORNALIERA A4**

Agenda in matra. Interno multilingue, stampa 2 colori, carta bianca, **sabato e domenica separati**. Rubrica telefonica, cartina geografica. Festività internazionali. Pagine perforate.



-  Matra
-  21 x 30 cm
-  1/14

**AD 1640
AGENDINA**

Agendina settimanale in matra. Interno multilingue, carta bianca. Rubrica telefonica.



Matra



8 x 15 cm



10/100



AR

RO

AZ

BO

BI



BL

GR

NE

VE

RY

**AD 1645
AGENDINA**

Agendina bigiornaliera in matra. Interno multilingue, carta bianca. Rubrica telefonica.



Matra



7 x 10 cm



10/100



RY

BL

BO



RO

NE

VE

BL



BI



RY



AR



AZ



GR



RO



BO



NE



VE



**AD 1650
PLANNING**

Planning da tavolo in matra con spirale.



Matra



30 x 15 cm





1/20

AD 1654 AGENDA

Agenda giornaliera in matra. Interno multilingue, stampa 2 colori, carta bianca, sabato e domenica abbinati. Rubrica telefonica, cartina geografica. Festività internazionali.



-  Matra
-  15 x 21 cm
-  1/20



AD 1657 AGENDINA

Agendina settimanale in matra. Interno multilingue, carta bianca. Rubrica telefonica.





-  Matra
-  8 x 15 cm
-  10/100



AD 1652 PLANNING

Planning da tavolo in matra con spirale.



-  Matra
-  30 x 15 cm
-  1/20



promosolution 2020|2021

CARTELLE PORTADOCUMENTI
CARTELLE PORTA PC
ZAINI PORTA PC
CARTELLE SOTTOBRACCIO
CARTELLE PORTABLOCCO
TACCUINI
NOTES





AF 1655 ZAINO PORTACOMPUTER

Zaino in poliestere con due scomparti con chiusura a doppia zip, scomparto con interno imbottito per tablet e computer portatile 15", scomparto secondario con varie tasche interne, tre tasche esterne frontali con cerniera piu' due tasche laterali, due spallacci imbottiti e regolabili, in elegante scatola regalo.



Poliestere



35 x 45 x 18 cm



1/1



BL



GR



AF 1656 ZAINO ANTIFURTO

Zaino in nylon con due scomparti con chiusura a doppia zip, scomparto con interno imbottito per tablet e computer portatile 15", connettore USB, varie tasche interne, tasca segreta con zip sul retro, due spallacci imbottiti e regolabili.



Nylon



33 x 44 x 12 cm





1/10



AF 1659 ZAINO ANTIFURTO

bicolore semirigido, parte centrale in nylon e parte superiore e inferiore in PVC, ampio scomparto interno, tasca porta computer da 15 pollici, varie tasche interne, porta USB esterna con cavo all'interno, tasca segreta con cerniera sul retro, bretelle imbottite regolabili.

-  Nylon + PVC
-  45x35x11 cm
-  1/10



AF 1665 ZAINO PORTACOMPUTER

Zaino portacomputer 15 pollici, scomparto principale con vano imbottito per un portatile, tasche interne, vano sulla parte anteriore con chiusura lampo, manico, spallacci regolabili.



Poliestere 600D e PVC



44,0 x 28,5 x 12,0 cm



1/10



AF 1663 ZAINO BUSINESS

con vano principale, vano imbottito per computer portatile e tablet da 15", connettore usb, tasca con cerniera sul davanti e tasca segreta con cerniera sul retro. Materiale nylon.



Nylon



44x31x13 cm





1/10





AF 1669 ZAINO PORTACOMPUTER

Zaino in nylon con due scomparti, scomparto principale con interno imbottito per computer portatile, scomparto secondario con varie tasche interne, due tasche esterne frontali con cerniera e due tasche a rete sui lati, due spallacci imbottiti, manico con impugnatura ergonomica.

	Nylon
	45x30x15 cm
	1/10

AF 1677 BORSA PORTACOMPUTER



Porta computer primo scomparto con cerniera per portatile e 3 tasche, secondo scomparto con ampia funzione organizer a cerniera, tasca anteriore e sul retro a strappo, maniglia rinforzata a strappo, tracolla regolabile ed asportabile con parte imbottita.

	POLIESTERE 600D
	40 x 30 x 13 cm
	1/20



AF 1710 PORTABLOCCO A4

Portablocco in pvc e microfibra con manici a scomparsa. Con calcolatrice e blocco carta da 20 fogli. Tasche interne portadocumenti e portacard.

	PVC - Microfibra
	34x25,5x2,5 cm
	1/15



**AF 1687
BORSA**

Portadocumenti bicolore. Chiusura con zip. Tasca laterale portaoggetti. Doppio manico. Tracolla regolabile. Comoda tasca anteriore con zip. Confezione in polybag.



Poliestere 600D



38x28x9,5 cm



1/40



**AF 1689
BORSA**

Messenger con ampio vano principale con patella frontale. Ampia tasca esterna con zip. Compartimento interno foderato che permette l'inserimento di un portatile da 17". Tasche laterali a rete. Tracolla regolabile.



Poliestere 600 D



40,5x25,5x10 cm



1/10



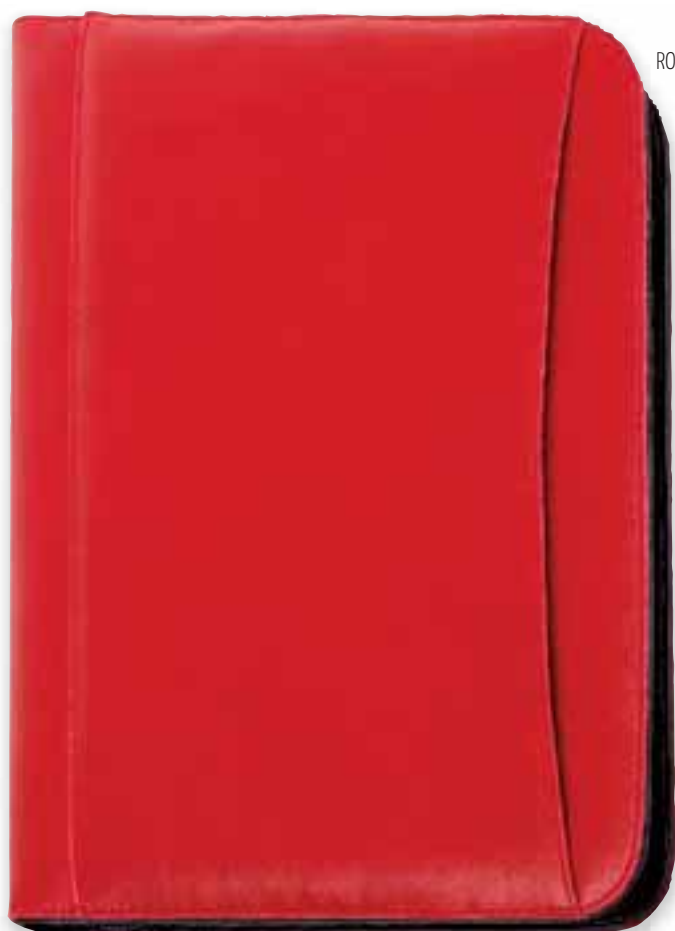

RO



NE



BL



AF 1718 PORTABLOCCO A4

Portablocco congresso in neopel 2 ante. Chiusura con zip. Varie tasche interne per documenti, uno scomparto interno con cerniera. Una tasca esterna. Completa di blocco e calcolatrice.



Neopel



34,5x26x3 cm



1/15

AF 1715 PORTABLOCCO A4

formato A4 richiudibile con elastico colorato, laccetto per penna, diversi scomparti, blocco notes incluso.



Poliestere / PU



32,5x25x1 cm



1/20



RO



GR

AZ

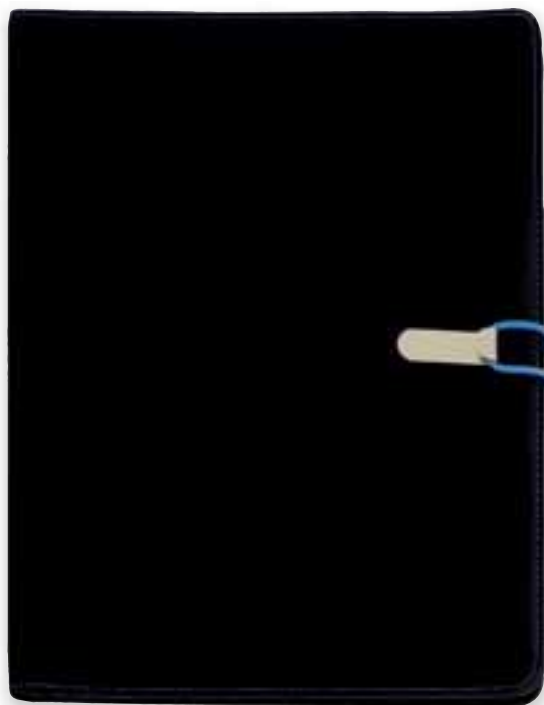

AF 1712 PORTABLOCCO A4

Prendi appunti in formato A4; con blocco per scrivere, anello per una penna, diverse taschine, all'esterno con laccio elastico a chiusura, interno colorato esterno nero.



Poliestere



32x26x2 cm



1/20



AZ



GR

VE



AF 1725 CARTELLINA A4

Cartella 2 ante, con pinza portablocco.
Confezione in polybag. (blocco notes e
penna non inclusi).



PVC



22x32 cm



1/50

BL



BI



RO



AF 1719 BUSTA PORTADOCUMENTI

Formato A4, chiusura lampo, in PVC
trasparente.



PVC



23,8 x 32,8 cm



1/100

AZ

VE



BI



AF 1720
BUSTA
PORTADOCUMENTI

Busta portadocumenti, chiusura con bottone. Confezione in polybag.



PVC



33,5x24 cm



20/200

RO



BL



AR



VE



TR

AF 1721
BUSTA
PORTADOCUMENTI

Busta portadocumenti, chiusura con bottone. Confezione in polybag.



PVC



24x17 cm



20/300

RO



BL



AR



VE



TR

RO



RO



BL



GR



BI



AF 1733 TACCUINO A6

Formato A6 , copertina in PP, interno 65 pagine a righe, dotato di penna a sfera in plastica con clip in metallo, refill blu.



Polipropilene



15X13X1,3 cm



1/30

AF 1734 TACCUINO A5

Formato A5 , copertina in PP, interno 65 pagine a righe, dotato di penna a sfera in plastica con clip in metallo, refill blu.



Polipropilene



21x17,8 cm



1/80

AF 1735 CARTELLA PORTADOCUMENTI

Include 150 segnapagina adesivi in vari colori, block-notes a righe da 25 pagine, penna a sfera refill blu con fusto e clip in cartone.



Cartone 600 gr



33,7 x 26 cm



1/40



AF 1731 CARTELLA DI SCRITTURA

Cartella da scrittura con blocco interno da 20 fogli formato +/- A4, penna in cartone con refill nero, set memo in 4 colori con 25 fogli per colore, manico integrato.



Cartone 600 gr



34,5 x 28,9 x 2,3 cm



1/25



VE



VE



BL



BI



AR



GI



NE



RO



AF 1738 BLOCK NOTES A6

Blocco notes, chiusura con elastico e segnalibro. In PU colorato.



Poliuretano



9x14x1,3 cm



25/200

AF 1746 BLOCK NOTES A5

Blocco notes, chiusura con elastico e segnalibro. In PU colorato.



Poliuretano



14x21x1,5 cm



25/100



AF 1737 BLOCK NOTES A6

Blocco notes bianco, chiusura con elastico,
80 pagine interne a righe, segnalibro.



Midi Cartonato



14x9x1,3 cm



40/240

AF 1750 BLOCK NOTES A5

Blocco notes bianco, chiusura con elastico,
80 pagine interne a righe, segnalibro.



Midi Cartonato





20,7x14,2x1,3 cm



25/200

AF 1739 BLOCK NOTES

Da 60 fogli, spiralato "ECO PAPER" Completo di penna refill blu. Confezione in astuccio.

-  Cartoncino /Metallo
-  18X13,5x1 cm
-  20/100



AR

AZ



VE



RO

AF 1743 BLOCK NOTES A6

Blocco notes in cartoncino con penna, biodegradabile, chiusura con elastico.

-  Cartoncino biodegradabile
-  14 x 9,8 x 0,9 cm
-  50/200

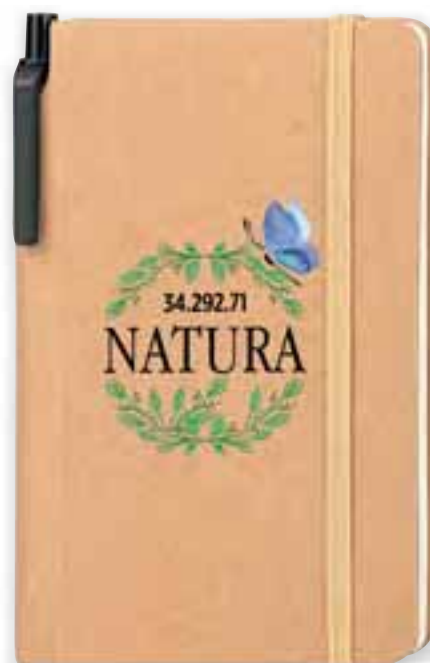

AF 1745
BLOCK NOTES A6

Blocco notes in sughero con penna in cartoncino biodegradabile, chiusura con elastico.



Sughero



10 x 14 x 1,3 cm



50/200

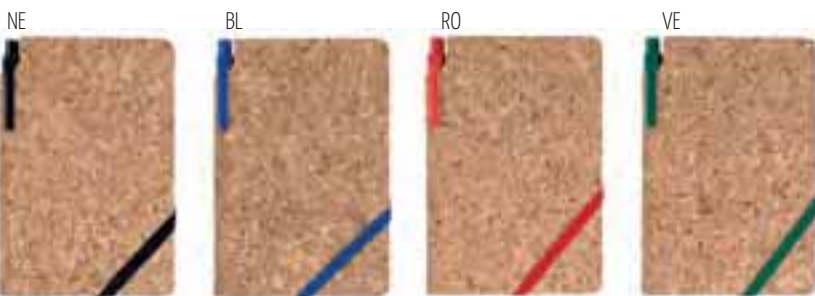

AF 1747
BLOCK NOTES A5

Blocco notes in cartoncino con penna , biodegradabile, chiusura con calamite,



Cartoncino biodegradabile



21 x 14,7 x 1,8 cm



25/100

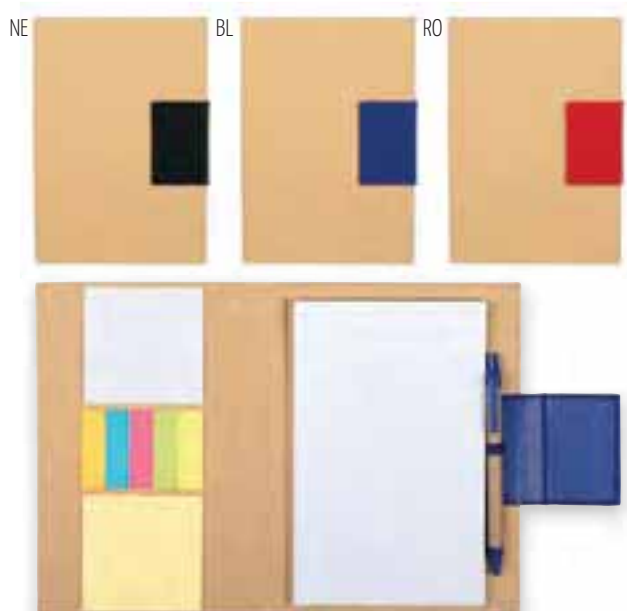

AF 1760 MINI QUADERNO

Quaderno in "ECO PAPER" con post-it, penna a sfera refill nero.



ECOPAPER



10,5x8 cm



100/400



AF 1742 BLOCK NOTES

Blocco notes in cartone, 80 fogli a righe, penna a sfera refill nero con fusto in cartone.



Cartoncino



8,9x11,1 cm



50/200



NE

AR

AZ

RO



AF 1763 MEMOBOX

Memo con foglietti adesivi e scomparto per bigliettini da visita, richiudibile con elastico, in materiale riciclato.



Cartoncino riciclato



10,5x6,8 cm



100/500



AF 1762 MEMOBOX

Memo con 120 foglietti, 20 graffette in scomparto nascosto, 100 bandierine segnalibro colorate, penna a sfera mini refill nero, copertina in cartone riciclabile.



Cartone/Plastica



16,5 x 10,4 x 2,2 cm



25/100



AF 1764 SET MEMO

Memo con spirale, 125 memo stick rettangolari in vari colori, 100 memo stick quadrati in vari colori.



Cartone/Metallo



7,5 x 8,0 x 2,5



25/200



AF 1759 SET MEMO

Set Memo Con righello 13 cm integrato, memo stick in 4 formati ed in vari colori, penna a sfera con corpo in cartone, refill blu.



Cartoncino riciclato



16,0 x 8,0 x 1,2 cm



50/200



AF 1765 SET MEMO CON PENNA

Set memo ECO style da scrivania, supporto in paglia di grano, include 100 fogli autoadesivi, foglie in silicone, penna a sfera in legno refill nero.



Paglia di grano/Silicone/Legno



11,5 x 6,5 x 2,5 cm



10/50



AF 1767 CUBO CARTA

Cubo in carta bianca usomano.



Carta



9,6 x 9,6 x 9,6 cm



24/96

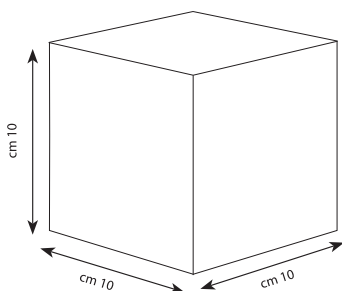

AF 1768 MINI CUBO PORTAPENNA

Cubo in carta bianca usomano con cartoncino portapenna.



Carta



11,5 x 11,5 x 3,8 cm



12/120

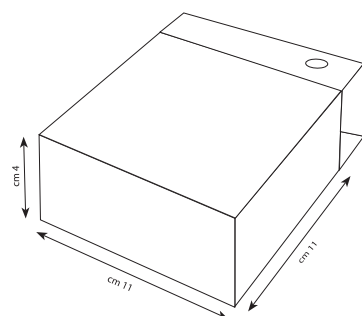

promosolution2020|2021

CALENDARI DA PARETE
CALENDARI DA TAVOLO
PLANNING



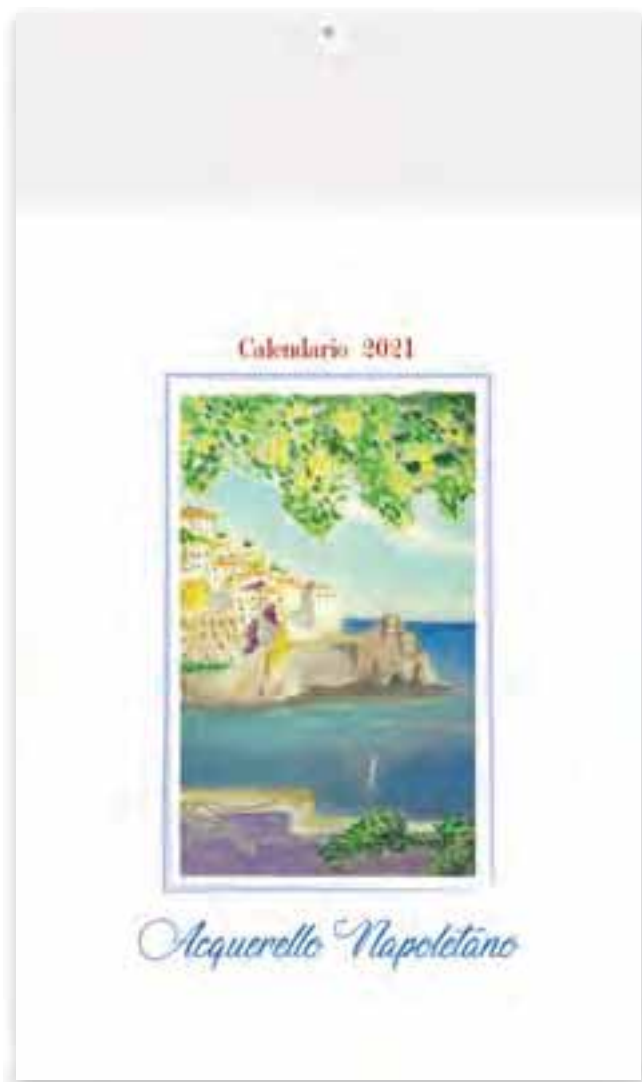

GENNAIO

FEBBRAIO

MARZO

APRILE

MAGGIO

GIUGNO

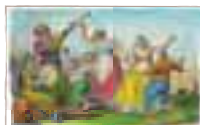

LUGLIO

AGOSTO

SETTEMBRE

OTTOBRE

NOVEMBRE

DICEMBRE

AG 1776
ACQUERELLO NAPOLETANO

Calendario mensile 13 fogli. Carta patinata opaca stampa 4 colori. Testata rigida rinforzata in triplo cartoncino.



Carta patinata opaca 90 gr



Calendario 31 x 53 cm
Testata 31 x 10,8 cm



100



GENNAIO

FEBBRAIO

MARZO

APRILE

MAGGIO

GIUGNO

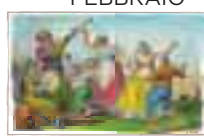

LUGLIO

AGOSTO

SETTEMBRE

OTTOBRE

NOVEMBRE

DICEMBRE

AG 1778
ACQUERELLO NAPOLETANO
DA TAVOLO

Spiralato 13 fogli carta patinata, planning 2021 e 2022 sul retro.



Carta patinata opaca 100 gr



Calendario 19 x 14,5 cm
 Spazio Stampa 19 x 4 cm



100



RETRO

GENNAIO



FEBBRAIO



MARZO



APRILE



MAGGIO



GIUGNO



LUGLIO



AGOSTO



SETTEMBRE



OTTOBRE



NOVEMBRE



DICEMBRE



**AG 2000
PAPA FRANCESCO**

Calendario mensile 12 fogli, Carta Patinata Stampa 4 colori fronte/retro, Festività Internazionali, Testata Termosaldata.



Carta patinata 70 gr



Calendario 28,8 x 47 cm
Testata 28,8 x 9 cm



100

RETRO



GENNAIO

FEBBRAIO

MARZO

APRILE

MAGGIO

GIUGNO



LUGLIO

AGOSTO

SETTEMBRE

OTTOBRE

NOVEMBRE

DICEMBRE

**AG 2001
SAN PIO**

Calendario mensile 12 fogli, Carta Patinata Stampa 4 colori fronte/retro, Festività Internazionali, Testata Termosaldata.



Carta patinata 70 gr



Calendario 28,8 x 47 cm
Testata 28,8 x 9 cm



100



RETRO



GENNAIO

FEBBRAIO

MARZO

APRILE

MAGGIO

GIUGNO



LUGLIO

AGOSTO

SETTEMBRE

OTTOBRE

NOVEMBRE

DICEMBRE

**AG 1950
CITTA' ITALIANE**

Calendario mensile 12 fogli, Carta Patinata Stampa 4 colori fronte/retro, Festività Internazionali, Testata Termosaldata.



Carta patinata 70 gr



Calendario 28,8 x 47 cm
Testata 28,8 x 9 cm



100

RETRO



GENNAIO

FEBBRAIO

MARZO

APRILE

MAGGIO

GIUGNO



LUGLIO

AGOSTO

SETTEMBRE

OTTOBRE

NOVEMBRE

DICEMBRE

**AG 1957
CITTA' DEL MONDO**

Calendario mensile 12 fogli, Carta Patinata Stampa 4 colori fronte/retro, Festività Internazionali, Testata Termosaldata.



Carta patinata 70 gr



Calendario 28,8 x 47 cm
Testata 28,8 x 9 cm



100



RETRO



GENNAIO



FEBBRAIO



MARZO



APRILE



MAGGIO



GIUGNO



LUGLIO



AGOSTO



SETTEMBRE



OTTOBRE



NOVEMBRE



DICEMBRE



**AG 1955
MOTORI**

Calendario mensile 12 fogli, Carta Patinata Stampa 4 colori fronte/retro, Festività Internazionali, Testata Termosaldata.



Carta patinata 70 gr



Calendario 28,8 x 47 cm
Testata 28,8 x 9 cm



100

RETRO



GENNAIO

FEBBRAIO

MARZO

APRILE

MAGGIO

GIUGNO



LUGLIO

AGOSTO

SETTEMBRE

OTTOBRE

NOVEMBRE

DICEMBRE

**AG 1965
HOME DESIGN**

Calendario mensile 12 fogli, Carta Patinata Stampa 4 colori fronte/retro, Festività Internazionali, Testata Termosaldata.



Carta patinata 70 gr



Calendario 28,8 x 47 cm
Testata 28,8 x 9 cm



100



RETRO



GENNAIO FEBBRAIO MARZO APRILE MAGGIO GIUGNO LUGLIO AGOSTO SETTEMBRE OTTOBRE NOVEMBRE DICEMBRE

**AG 1960
FIORI**

Calendario mensile 12 fogli, Carta Patinata Stampa 4 colori fronte/retro, Festività Internazionali, Testata Termosaldata.



Carta patinata 70 gr



Calendario 28,8 x 47 cm
Testata 28,8 x 9 cm



100

RETRO



AG 1962 LUNARIO

Calendario mensile 12 fogli, Carta Patinata Stampa 4 colori fronte/retro, Festività Internazionali, Testata Termosaldata.



Carta patinata 70 gr



Calendario 28,8 x 47 cm
Testata 28,8 x 9 cm



100

RETRO



**AG 1966
ASTROLOGIA**

Calendario mensile 12 fogli, Carta Patinata Stampa 4 colori fronte/retro, Festività Internazionali, Testata Termosaldata.



Carta patinata 70 gr



Calendario 28,8 x 47 cm
Testata 28,8 x 9 cm



100

RETRO



**AG 2025
4 STAGIONI**

Calendario mensile 12 fogli, Carta Patinata Stampa 4 colori fronte/retro, Festività Internazionali, Testata Termosaldata.



Carta patinata 70 gr



Calendario 28,8 x 47 cm
Testata 28,8 x 9 cm



100







RETRO



AG 2020 CABALA

Calendario mensile 12 fogli, Carta Patinata Stampa 4 colori fronte/retro, Festività Internazionali, Testata Termosaldata.



-  Carta patinata 70 gr
-  Calendario 28,8 x 47 cm
-  Testata 28,8 x 9 cm
-  100

RETRO



GENNAIO FEBBRAIO MARZO APRILE MAGGIO GIUGNO LUGLIO AGOSTO SETTEMBRE OTTOBRE NOVEMBRE DICEMBRE

AG 2022 FARMACIA

Calendario mensile 12 fogli, Carta Patinata Stampa 4 colori fronte/retro, Festività Internazionali, Testata Termosaldata.



Carta patinata 70 gr



Calendario 28,8 x 47 cm
Testata 28,8 x 9 cm



100



RETRO



GENNAIO



FEBBRAIO



MARZO



APRILE



MAGGIO



GIUGNO



LUGLIO



AGOSTO



SETTEMBRE



OTTOBRE



NOVEMBRE



DICEMBRE



**AG 2006
BARBER SHOP**

Calendario mensile 12 fogli, Carta Patinata Stampa 4 colori fronte/retro, Festività Internazionali, Testata Termosaldata.



Carta patinata 70 gr



Calendario 28,8 x 47 cm
Testata 28,8 x 9 cm



100

RETRO



GENNAIO

FEBBRAIO

MARZO

APRILE

MAGGIO

GIUGNO



LUGLIO

AGOSTO

SETTEMBRE

OTTOBRE

NOVEMBRE

DICEMBRE

AG 2021 CUCCIOLI

Calendario mensile 12 fogli, Carta Patinata Stampa 4 colori fronte/retro, Festività Internazionali, Testata Termosaldata.



Carta patinata 70 gr



Calendario 28,8 x 47 cm
Testata 28,8 x 9 cm



100



RETRO



**AG 2002
RAGAZZI DA COLORARE**

Calendario mensile 12 fogli da colorare, carta patinata stampa 4 colori fronte/retro, Festività internazionali. Testata termosaldata.



Carta patinata 70 gr



Calendario 28,8 x 47 cm
Testata 28,8 x 9 cm



100



**AG 2005
MONDO DELL'INFANZIA**

Calendario mensile 12 fogli, Carta Patinata Stampa 4 colori fronte/retro, Festività Internazionali, Testata Termosaldata.



- Carta patinata 70 gr
- Calendario 28,8 x 47 cm
- Testata 28,8 x 9 cm
- 100



RETRO



GENNAIO

FEBBRAIO

MARZO

APRILE

MAGGIO

GIUGNO



LUGLIO

AGOSTO

SETTEMBRE

OTTOBRE

NOVEMBRE

DICEMBRE

**AG 1892
PIZZA**

Calendario mensile 12 fogli, carta patinata stampa 4 colori fronte/retro, festività internazionali. Testata termosaldata.



Carta patinata 70 gr



Calendario 28,8 x 47 cm
Testata 28,8 x 9 cm



100

RETRO



GENNAIO



FEBBRAIO



MARZO



APRILE



MAGGIO



GIUGNO



LUGLIO



AGOSTO



SETTEMBRE



OTTOBRE



NOVEMBRE



DICEMBRE



AG 1984
PANE

Calendario mensile 12 fogli, Carta Patinata Stampa 4 colori fronte/retro, Festività Internazionali, Testata Termosaldata.



Carta patinata 70 gr



Calendario 28,8 x 47 cm
Testata 28,8 x 9 cm



100



RETRO

GENNAIO



FEBBRAIO



MARZO



APRILE



MAGGIO



GIUGNO



LUGLIO



AGOSTO



SETTEMBRE



OTTOBRE



NOVEMBRE



DICEMBRE



**AG 1970
ECCELLENZE ITALIANE**

Calendario mensile 12 fogli, carta patinata stampa 4 colori fronte/retro, Festività internazionali. Testata termosaldata.



Carta patinata 70 gr



Calendario 28,8 x 47 cm
Testata 28,8 x 9 cm



100





RETRO



**AG 2023
CUCINA**

Calendario mensile 12 fogli, Carta Patinata Stampa 4 colori fronte/retro, Festività Internazionali, Testata Termosaldata.



-  Carta patinata 70 gr
-  Calendario 28,8 x 47 cm
Testata 28,8 x 9 cm
-  100

RETRO



GENNAIO



FEBBRAIO



MARZO



APRILE



MAGGIO



GIUGNO



LUGLIO



AGOSTO



SETTEMBRE



OTTOBRE



NOVEMBRE



DICEMBRE



AG 2026
CARNE IN TAVOLA

Calendario mensile 12 fogli, carta patinata stampa 4 colori fronte/retro, Festività internazionali. Testata termosaldata.



Carta patinata 70 gr



Calendario 28,8 x 47 cm
Testata 28,8 x 9 cm



100

RETRO



GENNAIO

FEBBRAIO

MARZO

APRILE

MAGGIO

GIUGNO



LUGLIO

AGOSTO

SETTEMBRE

OTTOBRE

NOVEMBRE

DICEMBRE

**AG 2027
SAPORI DEL MARE**

Calendario mensile 12 fogli, Carta Patinata Stampa 4 colori fronte/retro, Festività Internazionali, Testata Termosaldata.



Carta patinata 70 gr



Calendario 28,8 x 47 cm
Testata 28,8 x 9 cm



100



RETRO



GENNAIO



FEBBRAIO



MARZO



APRILE



MAGGIO



GIUGNO



LUGLIO



AGOSTO



SETTEMBRE



OTTOBRE



NOVEMBRE



DICEMBRE



**AG 1987
FRUTTA & VERDURA**

Calendario mensile 12 fogli, carta patinata stampa 4 colori fronte/retro, Festività internazionali. Testata termosaldada.



Carta patinata 70 gr



Calendario 28,8 x 47 cm
Testata 28,8 x 9 cm



100

RETRO



GENNAIO FEBBRAIO MARZO APRILE MAGGIO GIUGNO LUGLIO AGOSTO SETTEMBRE OTTOBRE NOVEMBRE DICEMBRE

**AG 1988
DOLCI E PIACERI**

Calendario mensile 12 fogli, Carta Patinata Stampa 4 colori fronte/retro, Festività Internazionali, Testata Termosaldata.



Carta patinata 70 gr



Calendario 28,8 x 47 cm
Testata 28,8 x 9 cm



100



**AG 1840
FORMULA UNO**

Bimensile 6 fogli, carta patinata stampa 4 colori. Testata termosaldata.



Carta patinata 80 gr



Calendario 32 x 48 cm
Testata 32 x 10 cm



100



AG 1845
MOTO MONDIALE

Bimensile 6 fogli, carta patinata stampa 4 colori. Testata termosaldata.



Carta patinata 80 gr



Calendario 32 x 48 cm
Testata 32 x 10 cm



100



RETRO



RETRO



**AG 2046
SILHOUETTE
MILK & COFFEE**

Calendario mensile 12 fogli, Carta Patinata Stampa 4 colori fronte/retro, Festività Internazionali, Testata Termosaldata.



Carta patinata 70 gr



Calendario 14 x 47 cm
Testata 14 x 9 cm



100



**AG 2048
SILHOUETTE
FARMACIA**

Calendario mensile 12 fogli, Carta Patinata Stampa 4 colori fronte/retro, Festività Internazionali, Testata Termosaldata.



Carta patinata 70 gr



Calendario 14 x 47 cm
Testata 14 x 9 cm



100





RETRO



RETRO



**AG 2044
SILHOUETTE
CUCINA**

Calendario mensile 12 fogli, Carta Patinata Stampa 4 colori fronte/retro, Festività Internazionali, Testata Termosaldata.



Carta patinata 70 gr



Calendario 14 x 47 cm
Testata 14 x 9 cm



100



**AG 2047
SILHOUETTE
CARNE IN TAVOLA**

Calendario mensile 12 fogli, Carta Patinata Stampa 4 colori fronte/retro, Festività Internazionali, Testata Termosaldata.



Carta patinata 70 gr



Calendario 14 x 47 cm
Testata 14 x 9 cm



100





RETRO



RETRO



**AG 2039
SILHOUETTE
PAPA FRANCESCO**

Calendario mensile 12 fogli, Carta Patinata Stampa 4 colori fronte/retro, Festività Internazionali, Testata Termosaldata.



Carta patinata 70 gr



Calendario 14 x 47 cm
Testata 14 x 9 cm



100



**AG 2042
SILHOUETTE
SAN PIO**

Calendario mensile 12 fogli, Carta Patinata Stampa 4 colori fronte/retro, Festività Internazionali, Testata Termosaldata.



Carta patinata 70 gr



Calendario 14 x 47 cm
Testata 14 x 9 cm



100





RETRO



RETRO



**AG 2043
SILHOUETTE
CUCCIOLI**

Calendario mensile 12 fogli, Carta Patinata Stampa 4 colori fronte/retro, Festività Internazionali, Testata Termosaldata.



Carta patinata 70 gr



Calendario 14 x 47 cm
Testata 14 x 9 cm



100



**AG 2045
SILHOUETTE
CITTA' D'ITALIA**

Calendario mensile 12 fogli, Carta Patinata Stampa 4 colori fronte/retro, Festività Internazionali, Testata Termosaldata.



Carta patinata 70 gr



Calendario 14 x 47 cm
Testata 14 x 9 cm



100





RETRO



RETRO



**AG 2040
SILHOUETTE
MULTICOLOR**

Calendario mensile 12 fogli, Carta Patinata Stampa 4 colori fronte/retro, Planning 2021 su retro dicembre, Festività Internazionali, Testata Termosaldata.



Carta patinata 70 gr



Calendario 14 x 47 cm
Testata 14 x 9 cm



100



**AG 2041
SILHOUETTE
STYLE**

Calendario mensile 12 fogli, Carta Patinata Stampa 4 colori fronte/retro, Planning 2021 su retro dicembre, Festività Internazionali, Testata Termosaldata.



Carta patinata 70 gr



Calendario 14 x 47 cm
Testata 14 x 9 cm



100





**AG 2051
OLANDESE MEDIO
MULTICOLOR**

Calendario mensile 12 fogli, carta patinata. Stampa 4 colori, Testata Termosaldata.



Carta patinata 80 gr



Calendario 22 x 47,4 cm
Testata 22 x 9 cm



100



**AG 2055
OLANDESE
MEDIO STYLE**

Calendario Mensile 12 fogli. Stampa 4 colori, testata termosaldata.



Carta patinata 80 gr



Calendario 22 x 47,4 cm
Testata 22 x 9 cm



100



VE

RETRO



BL



RO



**AG 2010
OLANDESE MEDIUM**

Calendario mensile 12 fogli, Carta Patinata, Stampa 2 colori, Planning 2021 su retro dicembre, Festività Internazionali, Testata Termosaldata.



Carta patinata 70 gr



Calendario 28,8 x 42,5 cm
Testata 28,8 x 9 cm



100

RO



RETRO



VE



AZ



CALENDARI

**AG 2011
OLANDESE STANDARD**

Calendario mensile 12 fogli, Carta Patinata, Stampa 2 colori, Planning 2021 su retro dicembre, Festività Internazionali, Testata Termosaldata.



Carta patinata 70 gr



Calendario 28,8 x 47 cm
Testata 28,8 x 9 cm



100

RO

VE



BL



**AG 2034
MAXI OLANDESE**

Calendario mensile 12 fogli, carta patinata,
Stampa 2 colori, testata termosaldata.



Carta patinata 80 gr



Calendario: 31 x 49 cm
Testata : 31 x 10 cm



100

RO

VE



BL



AG 2035 MAXI OLANDESE NOTE

Mensile 12 fogli, carta uso mano 80 gr. stampa 2 colori.
Testata doppio strato rinforzata.



Carta uso mano 80 gr



Calendario 31 x 53 cm
Testata 31 x 10,8 cm



100



**AG 2014
OLANDESE STANDARD
MULTICOLOR**

Calendario mensile 12 fogli, Carta Patinata, Stampa 4 colori, Planning 2021 su retro dicembre, Festività Internazionali, Testata Termosaldata.



Carta patinata 70 gr



Calendario 28,8 x 47 cm
Testata 28,8 x 9 cm



100

RO

RETRO



BL



VE



CALENDARI

**AG 2015
OLANDESE TRENDY**

Calendario mensile 12 fogli, Carta Patinata, Stampa 2 colori, Planning 2021 su retro dicembre, Festività Internazionali, Testata Termosaldata.



Carta patinata 70 gr



Calendario 28,8 x 47 cm
Testata 28,8 x 9 cm



100

BL

RETRO



RO



VE



**AG 2012
OLANDESE NOTES**

Calendario mensile 12 fogli, Carta Patinata, Stampa 2 colori, Planning 2021 su retro dicembre, Festività Internazionali, Testata Termosaldata.



Carta patinata 70 gr



Calendario 28,8 x 47 cm
Testata 28,8 x 9 cm



100



**AG 2013
OLANDESE NOTES
MULTICOLOR**

Calendario mensile 12 fogli, Carta Patinata, Stampa 4 colori, Planning 2021 su retro dicembre, Festività Internazionali, Testata Termosaldata.



Carta patinata 70 gr



Calendario 28,8 x 47cm
Testata 28,8 x 9 cm



100



**AG 2057
OLANDESE STYLE**

Calendario mensile 12 fogli, Carta Patinata, Stampa 4 colori, Planning 2021 su retro dicembre, Festività Internazionali, Testata Termosaldata.



Carta patinata 70 gr



Calendario 28,8 x 47 cm
Testata 28,8 x 9 cm



100



RETRO

AG 2083
CALENDARIO
DA TAVOLO STYLE

Spiralato 12 fogli + copertina carta patinata opaca. Planning 2020 e 2021 sul retro.



Carta patinata opaca 100 gr



Calendario 12,5 x 20 cm
Spazio Stampa 11 x 3 cm



100



AG 2041
SILHOUETTE
STYLE

Calendario mensile 12 fogli, Carta Patinata Stampa 4 colori fronte/retro, Planning 2021 su retro dicembre, Festività Internazionali, Testata Termosaldata.



Carta patinata 70 gr



Calendario 14 x 47 cm
Testata 14 x 9 cm



100



AR

BL



VE



**AG 2016
PORTOGHESE MAXI**

Calendario mensile 12 fogli . Carta patinata stampa 2 colori. Testata rigida rinforzata in triplo cartoncino.



Carta patinata 90 gr



Calendario 31 x 53 cm
Testata 31 x 10,8 cm



100



AG 2072 PORTOGHESE DA TAVOLO

Spiralato 13 fogli carta patinata. Planning 2020 e 2021 sul retro.



Carta patinata 100 gr



Calendario 19 x 14 cm
Spazio Stampa 19 x 4 cm



100



RETRO



AG 2084 TRICOLORE DA TAVOLO

Spiralato 13 fogli carta patinata. Planning 2020 e 2021 sul retro.



Carta patinata 100 gr



Calendario 19 x 14 cm
Spazio Stampa 19 x 4 cm



100



AG 1994 TRICOLORE

Calendario mensile 12 fogli, Carta patinata. Testata rinforzata.



Carta patinata opaca 90 gr



Calendario 31 x 53 cm
Testata 31 x 10,8 cm



100



 GENNAIO 2021	
1 VENERDI Festa della Epifania	17 DOMENICA S. Rocco
2 SABATO S. Basilio e Gregorio	18 LUNEDI S. Lorenzo
3 DOMENICA S. Spirito	19 MARTEDI S. Sebastiano
4 LUNEDI S. Felice e Adelfo	20 MERCOLEDI S. Silvestro e Papa
5 MARTEDI S. Agostino	21 GIOVEDI S. Agostino
6 MERCOLEDI S. Vito	22 VENERDI S. Vito
7 GIOVEDI S. Pancrazio e Pавлик	23 SABATO S. Pancrazio
8 VENERDI S. Agostino	24 DOMENICA S. Francesco di Sales
9 SABATO S. Felice	25 LUNEDI S. Felice
10 DOMENICA S. Agostino	26 MARTEDI S. Agostino
11 LUNEDI S. Agostino	27 MERCOLEDI S. Agostino
12 MARTEDI S. Agostino	28 GIOVEDI S. Agostino
13 MERCOLEDI S. Agostino	29 VENERDI S. Agostino
14 GIOVEDI S. Agostino	30 SABATO S. Agostino
15 VENERDI S. Agostino	31 DOMENICA S. Agostino

 GENNAIO 2021	
1 VENERDI Festa della Epifania	17 DOMENICA S. Rocco
2 SABATO S. Basilio e Gregorio	18 LUNEDI S. Lorenzo
3 DOMENICA S. Spirito	19 MARTEDI S. Sebastiano
4 LUNEDI S. Felice e Adelfo	20 MERCOLEDI S. Silvestro e Papa
5 MARTEDI S. Agostino	21 GIOVEDI S. Agostino
6 MERCOLEDI S. Vito	22 VENERDI S. Vito
7 GIOVEDI S. Pancrazio e Pавлик	23 SABATO S. Pancrazio
8 VENERDI S. Agostino	24 DOMENICA S. Francesco di Sales
9 SABATO S. Felice	25 LUNEDI S. Felice
10 DOMENICA S. Agostino	26 MARTEDI S. Agostino
11 LUNEDI S. Agostino	27 MERCOLEDI S. Agostino
12 MARTEDI S. Agostino	28 GIOVEDI S. Agostino
13 MERCOLEDI S. Agostino	29 VENERDI S. Agostino
14 GIOVEDI S. Agostino	30 SABATO S. Agostino
15 VENERDI S. Agostino	31 DOMENICA S. Agostino

**AG 2060
OLANDESE MAXI QUADRETTATO**

Mensile 12 fogli. Allestimento con astina metallica.



Carta uso mano 80 gr



Calendario 33 X 71,5 cm
Testata 33 x 10 cm



100



AG 2053 OLANDESE ORGANIZER

Calendario mensile 12 fogli, Carta Patinata, Stampa 2 colori. Planning 2021 su retro dicembre, Festività Internazionali, Testata Termosaldata.



Carta patinata 70 gr



Calendario 28,8 x 47 cm
Testata 28,8 x 9 cm



100

g

20
21

12
mesi per
essere
felice

01. gentilezza

Ogni persona che incontri sta combattendo
una battaglia di cui non sai nulla.
Sii gentile. Sempre
(Platone)

gennaio

LUN	4	ss. Emerico e Carlo 7 gennaio	11	s. Ignazio 7 gennaio	18	s. Liberata - s. Margherita 7 gennaio	25	Comera di s. Paolo 7 gennaio
MAR	5	s. Anselmo	12	s. Costantino	19	s. Paolo e Marco	26	s. Teodoro
MER	6	Epifania di s. S.	13	s. Doroteo	20	ss. Sebastiano e Fabiano	27	s. Angiola Merici
GIO	7	s. Raimondo di Peafort	14	s. Felice	21	s. Agnese	28	s. Tommaso di Aquino
VEN	1	Maria Madre di Dio - Capodanno 27 ottobre	8	s. Pasquale	15	s. Mauro	22	s. Vincenzo e Anastasio
SAB	2	ss. Basilio e Gregorio	9	s. Giuliano - s. Abramo	16	s. Vivaldo	23	s. Cosma e Damiano
DOM	3	s. Cosetta	10	Battesimo di Gesù - s. Aldo	17	s. Antonio abate	24	s. Francesco di Sales
								31

12	20	M	M	G	V	S	D	L	M	M	G	V	S	D	L	M	M	G	V	S	D	L	M	M	G	V	S	D	L	M	M	G	V	S	D	
02	21	L	M	M	G	V	S	D	L	M	M	G	V	S	D	L	M	M	G	V	S	D	L	M	M	G	V	S	D	L	M	M	G	V	S	D
		1	2	3	4	5	6	7	8	9	10	11	12	13	14	15	16	17	18	19	20	21	22	23	24	25	26	27	28	29	30	31				



AG 2052 OLANDESE MULTIFLUO LUX

Calendario mensile 12 fogli, Carta Patinata, Stampa 4 colori fluo. Festività Internazionali, Testata Termosaldata.



INCHIOSTRI FLUO



Carta patinata 100 gr



Calendario 31 x 49 cm
Testata 31 x 10 cm



100

1 V <small>53ª settimana</small> Maria Madre di Dio - Cipodarno 1-364	20 M ss. Sebastiano e Fabiano 20-345																																											
2 S ss. Basilio e Gregorio 2-363	21 G s. Agnese 21-344																																											
3 D s. Genoveffa 3-362	22 V s. Vincenzo e Cauderato 22-343																																											
4 L <small>1ª settimana</small> ss. Ermete e Caio 4-361	23 S s. Emerenziana 23-342																																											
5 M s. Amata 5-360	24 D s. Francesco di Sales 24-341																																											
6 M <small>2ª settimana</small> Epifania di N.S. 6-359	25 L <small>3ª settimana</small> Convers. di s. Paolo 25-340																																											
7 G s. Raimondo di Peñafort 7-358	26 M ss. Tito e Timoteo 26-339																																											
8 V s. Massimo 8-357	27 M s. Angela Merici 27-338																																											
9 S s. Giuliano - S. Adriano 9-356	28 G s. Tommaso d'Aquino 28-337																																											
10 D Battesimo di Gesù - S. Albino 10-355	29 V s. Costanzo 29-336																																											
11 L <small>3ª settimana</small> s. Igho 11-354	30 S s. Martina 30-335																																											
12 M s. Cestia 12-353	31 D s. Giovanni Bosco 31-334																																											
13 M s. Felice 13-352	<p>Il Sole e la Luna</p> <table border="1"> <tr> <td>Giorno</td> <td>1</td> <td>ora 7,38</td> <td>ora 14,30</td> <td>☾ U.Q. giorno</td> <td>6</td> <td>ora 10,39</td> </tr> <tr> <td>Giorno</td> <td>2</td> <td>ora 7,38</td> <td>ora 14,30</td> <td>☾ L.N. giorno</td> <td>13</td> <td>ora 8,03</td> </tr> <tr> <td>Giorno</td> <td>13</td> <td>ora 7,38</td> <td>ora 17,22</td> <td>☾ P.Q. giorno</td> <td>20</td> <td>ora 22,04</td> </tr> <tr> <td>Giorno</td> <td>19</td> <td>ora 7,29</td> <td>ora 17,14</td> <td>☾ L.P. giorno</td> <td>28</td> <td>ora 20,19</td> </tr> <tr> <td>Giorno</td> <td>25</td> <td>ora 7,21</td> <td>ora 17,04</td> <td></td> <td></td> <td></td> </tr> <tr> <td>Giorno</td> <td>31</td> <td>ora 7,23</td> <td>ora 17,04</td> <td></td> <td></td> <td></td> </tr> </table>		Giorno	1	ora 7,38	ora 14,30	☾ U.Q. giorno	6	ora 10,39	Giorno	2	ora 7,38	ora 14,30	☾ L.N. giorno	13	ora 8,03	Giorno	13	ora 7,38	ora 17,22	☾ P.Q. giorno	20	ora 22,04	Giorno	19	ora 7,29	ora 17,14	☾ L.P. giorno	28	ora 20,19	Giorno	25	ora 7,21	ora 17,04				Giorno	31	ora 7,23	ora 17,04			
Giorno	1	ora 7,38	ora 14,30	☾ U.Q. giorno	6	ora 10,39																																						
Giorno	2	ora 7,38	ora 14,30	☾ L.N. giorno	13	ora 8,03																																						
Giorno	13	ora 7,38	ora 17,22	☾ P.Q. giorno	20	ora 22,04																																						
Giorno	19	ora 7,29	ora 17,14	☾ L.P. giorno	28	ora 20,19																																						
Giorno	25	ora 7,21	ora 17,04																																									
Giorno	31	ora 7,23	ora 17,04																																									
14 G s. Felice 14-351	<p>Dicembre 2020</p> <table border="1"> <thead> <tr> <th>Lun</th> <th>Mar</th> <th>Mer</th> <th>Gio</th> <th>Ven</th> <th>Sab</th> <th>Dom</th> </tr> </thead> <tbody> <tr> <td></td> <td>1</td> <td>2</td> <td>3</td> <td>4</td> <td>5</td> <td>6</td> </tr> <tr> <td>7</td> <td>8</td> <td>9</td> <td>10</td> <td>11</td> <td>12</td> <td>13</td> </tr> <tr> <td>14</td> <td>15</td> <td>16</td> <td>17</td> <td>18</td> <td>19</td> <td>20</td> </tr> <tr> <td>21</td> <td>22</td> <td>23</td> <td>24</td> <td>25</td> <td>26</td> <td>27</td> </tr> <tr> <td>28</td> <td>29</td> <td>30</td> <td>31</td> <td></td> <td></td> <td></td> </tr> </tbody> </table>		Lun	Mar	Mer	Gio	Ven	Sab	Dom		1	2	3	4	5	6	7	8	9	10	11	12	13	14	15	16	17	18	19	20	21	22	23	24	25	26	27	28	29	30	31			
Lun	Mar	Mer	Gio	Ven	Sab	Dom																																						
	1	2	3	4	5	6																																						
7	8	9	10	11	12	13																																						
14	15	16	17	18	19	20																																						
21	22	23	24	25	26	27																																						
28	29	30	31																																									
15 V s. Mauro 15-350	<p>Febbraio 2021</p> <table border="1"> <thead> <tr> <th>Lun</th> <th>Mar</th> <th>Mer</th> <th>Gio</th> <th>Ven</th> <th>Sab</th> <th>Dom</th> </tr> </thead> <tbody> <tr> <td>1</td> <td>2</td> <td>3</td> <td>4</td> <td>5</td> <td>6</td> <td>7</td> </tr> <tr> <td>8</td> <td>9</td> <td>10</td> <td>11</td> <td>12</td> <td>13</td> <td>14</td> </tr> <tr> <td>15</td> <td>16</td> <td>17</td> <td>18</td> <td>19</td> <td>20</td> <td>21</td> </tr> <tr> <td>22</td> <td>23</td> <td>24</td> <td>25</td> <td>26</td> <td>27</td> <td>28</td> </tr> </tbody> </table>		Lun	Mar	Mer	Gio	Ven	Sab	Dom	1	2	3	4	5	6	7	8	9	10	11	12	13	14	15	16	17	18	19	20	21	22	23	24	25	26	27	28							
Lun	Mar	Mer	Gio	Ven	Sab	Dom																																						
1	2	3	4	5	6	7																																						
8	9	10	11	12	13	14																																						
15	16	17	18	19	20	21																																						
22	23	24	25	26	27	28																																						
16 S s. Marcello 16-349	<p>ACQUARIO 21/01 - 19/02</p>																																											
17 D s. Antonio abate 17-348	<p>2021</p>																																											
18 L <small>3ª settimana</small> s. Liberata - S. Margherita 18-347																																												
19 M s. Miro e Marta 19-346																																												

L'IMPRESA DI PUBBLICITÀ, NEL RISPETTO DEL REGOLAMENTO LOCALE, È A CARICO DI CHI LO ESPONE IN PUBBLICO - PRODOTTO ITALIANO

AG 2056 OLANDESE MULTIFLUO

Calendario mensile 12 fogli, Carta Patinata, Stampa 4 colori fluo. Festività Internazionali, Testata Termosaldata.



INCHIOSTRI FLUO



Carta patinata 100 gr



Calendario 31 x 49 cm
Testata 31 x 10 cm



100

1	V	000000	07 set.	DICEMBRE 2020
2	S			Set 48 49 50 51 52
3	D			Lun 7 14 21 28
4	L		1° set.	Mar 1 8 15 22 29
5	M			Mer 2 9 16 23 30
6	M	000		Gio 3 10 17 24 31
7	G			Ven 4 11 18 25
8	V			Sab 5 12 19 26
9	S			Dom 6 13 20 27
10	D			
11	L		2° set.	
12	M			
13	M			
14	G			
15	V			
16	S			
17	D			
18	L		3° set.	
19	M			
20	M			
21	G			
22	V			
23	S			
24	D			
25	L		4° set.	
26	M			
27	M			
28	G			
29	V			
30	S			
31	D			

FEBBRAIO 2021

Set	05	06	07	08
Lun	1	8	15	22
Mar	2	9	16	23
Mer	3	10	17	24
Gio	4	11	18	25
Ven	5	12	19	26
Sab	6	13	20	27
Dom	7	14	21	28

Il Sole e la Luna

Giorno 1	ore 7.38	ore 16.50
Giorno 7	ore 7.38	ore 16.55
Giorno 13	ore 7.34	ore 17.02
Giorno 19	ore 7.33	ore 17.09
Giorno 25	ore 7.29	ore 17.16
Giorno 31	ore 7.23	ore 17.24

☾ L.Q. giorno 6 ore 10.39
 ☽ L.N. giorno 15 ore 6.03
 ☿ P.Q. giorno 20 ore 22.04
 ♁ L.P. giorno 28 ore 20.19



**AG 2054
SILHOUETTE MULTIFLUO**

Calendario mensile 12 fogli, Carta Patinata Stampa 4 colori fluo. Festività Internazionali, Testata Termosaldata.



INCHIOSTRI FLUO



Carta patinata 100 gr



Calendario 14 x 47 cm
Testata 14 x 9 cm



100

1 V Maria Madre di Dio - Capodanno 1-364

2 S ss. Basilio e Gregorio 2-363

3 D s. Genoveffa 3-362

4 L ss. Ermesto e Calo 4-361

5 M s. Amelia 5-360

6 M Epifania di N.S. 6-359

7 G s. Raimondo di Peñafort 7-358

8 V s. Massimo 8-357

9 S s. Giuliano - S. Adriano 9-356

10 D Battesimo di Gesù - S. Aldo 10-355

11 L s. Iginio 11-354

12 M s. Cesira 12-353

13 M s. Ilario 13-352

14 G s. Felice 14-351

15 V s. Mauro 15-350

16 S s. Marcello 16-349

17 D s. Antonio abate 17-348

18 L s. Liberata - S. Margherita 18-347

19 M s. Mario e Marta 19-346

20 M ss. Sebastiano e Fabiano 20-345

21 G s. Agnese 21-344

22 V s. Vincenzo e Caudenzio 22-343

23 S s. Emmerenziana 23-342

24 D s. Francesco di Sales 24-341

25 L Convers. di s. Paolo 25-340

26 M ss. Tito e Timoteo 26-339

27 M s. Angela Merici 27-338

28 G s. Tommaso d'Aquino 28-337

29 V s. Costanzo 29-336

30 S s. Martina 30-335

31 D s. Giovanni Bosco 31-334

ACQUARIO
21/01 - 19/02

Il Sole e la Luna

Giorno 1	ora 7.28	ora 16.55	U.O. giorno 8	ora 10.39
Giorno 15	ora 7.28	ora 16.55	S.N. giorno 13	ora 8.00
Giorno 21	ora 7.25	ora 17.02	P.O. giorno 20	ora 22.04
Giorno 28	ora 7.27	ora 17.16	L.P. giorno 28	ora 22.19
Giorno 31	ora 7.23	ora 17.24		

Dicembre 2020

Lun	Mar	Mer	Gio	Ven	Sab	Dom
	1	2	3	4	5	6
7	8	9	10	11	12	13
14	15	16	17	18	19	20
21	22	23	24	25	26	27
28	29	30	31			

Febbraio 2021

Lun	Mar	Mer	Gio	Ven	Sab	Dom
1	2	3	4	5	6	7
8	9	10	11	12	13	14
15	16	17	18	19	20	21
22	23	24	25	26	27	28

2021

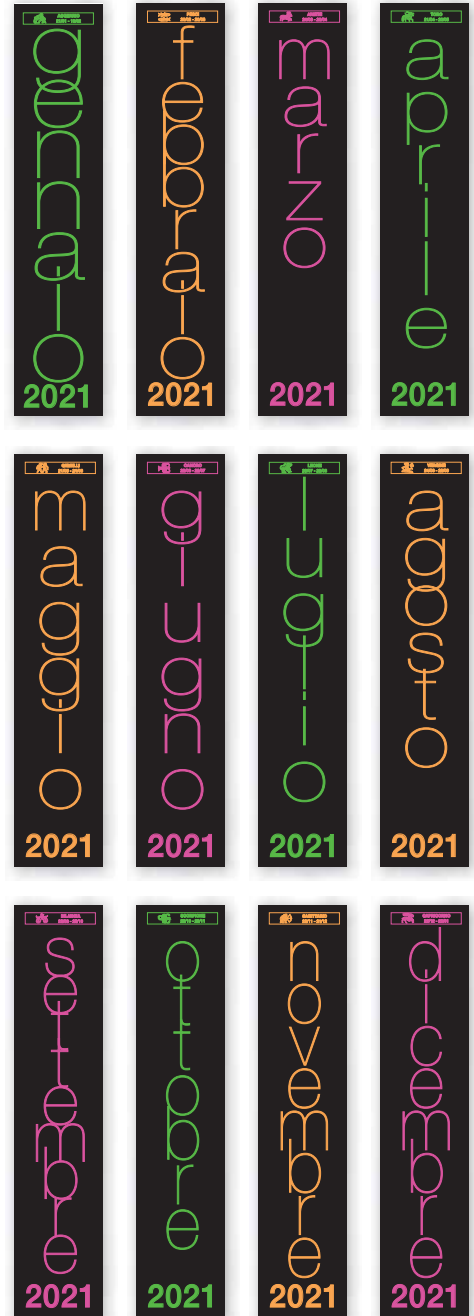

AG 2058 OLANDESE MULTIFLUO BLACK

Calendario mensile 12 fogli, Carta Patinata, Stampa 4 colori fluo. Festività Internazionali, Testata Termosaldata.



INCHIOSTRI FLUO



Carta patinata 100 gr



Calendario 31 x 49 cm
Testata 31 x 10 cm



100

1 V  5^a sett. Maria Madre di Dio - Capodanno

2 S ss. Basilio e Gregorio

3 D s. Genoveffa

4 L s. Ermoto e Calo

5 M s. Amela

6 M  Epifania di N.S.

7 G s. Raimondo di Peñafort

8 V s. Massimo

9 S s. Giuliano - S. Adriano

10 D Battesimo di Gesù - S. Aldo

11 L s. Igino

12 M s. Cesira

13 M s. Ilario

14 G s. Felice

15 V s. Mauro

16 S s. Marcello

17 D s. Antonio abate

18 L s. Liberata - S. Margherita

19 M s. Mario e Marta

20 M ss. Sebastiano e Fabiano

21 G s. Agnese

22 V s. Vincenzo e Cauderzio

23 S s. Emerenziana

24 D s. Francesco di Sales

25 L Convers. di s. Paolo

26 M ss. Tito e Timoteo

27 M s. Angela Merici

28 G s. Tommaso d'Aquino

29 V s. Costanzo

30 S s. Martina

31 D s. Giovanni Bosco

DICEMBRE 2020

Set	48	49	50	51	52
Lun	7	14	21	28	
Mar	1	8	15	22	29
Mer	2	9	16	23	30
Gio	3	10	17	24	31
Ven	4	11	18	25	
Sab	5	12	19	26	
Dom	6	13	20	27	

gen
io
na
20
21

FEBBRAIO 2021

Set	05	06	07	08
Lun	1	8	15	22
Mar	2	9	16	23
Mer	3	10	17	24
Gio	4	11	18	25
Ven	5	12	19	26
Sab	6	13	20	27
Dom	7	14	21	28

Il Sole e la Luna

Giorno 1	ore 7,38	ore 14,00
Giorno 7	ore 7,38	ore 14,55
Giorno 13	ore 7,34	ore 17,02
Giorno 19	ore 7,33	ore 17,09
Giorno 25	ore 7,29	ore 17,16
Giorno 31	ore 7,23	ore 17,24

 U.Q. giorno 6 ore 10,39
 L.N. giorno 13 ore 8,03
 P.Q. giorno 20 ore 22,04
 L.P. giorno 28 ore 20,19



AG 2059
SILHOUETTE MULTIFLUO BLACK

Calendario mensile 12 fogli, Carta Patinata Stampa 4 colori fluo. Festività Internazionali, Testata Termosaldata.



INCHIOSTRI FLUO



Carta patinata 100 gr



Calendario 14 x 47 cm
Testata 14 x 9 cm



100

BL



RO



VE



**AG 2031
PASSAFOGLI**

Mensile 12 fogli, carta uso mano 90 gr. stampa 2 colori.
Testata doppio strato rinforzata.



Carta uso mano 90 gr



Calendario 34 x 54 cm
Testata 34 x 9 cm



50

RO

BL



CALENDARI

VE

AG 2033 PASSAFOGLI

Mensile 12 fogli, carta patinata opaca, stampa 2 colori.
Testata doppio strato rinforzata. Allestito con astina in metallo.



Carta patinata opaca 90 gr



Calendario 32,5 x 54 cm
Testata 32,5 x 9 cm



100



AG 2062
TRITTICO BLACK

Trimestrale 12 fogli in carta patinata, testata rinforzata, cursore incluso.



Carta patinata 80 gr



Calendario 33 x 79 cm
Testata ca. 33 x 20 cm



50



AG 2063
QUADRITTICO BLACK

Quadrimestrale 12 fogli in carta patinata, testata rinforzata, cursore incluso.



Carta patinata 80 gr



Calendario 33x100 cm
Testata ca. 33x20 cm



40





AG 2065 TRITTICO

Trimestrale 12 fogli in carta patinata, testata rinforzata, cursore incluso.



Carta patinata 80 gr



Calendario 33 x 79 cm
Testata ca. 33 x 20 cm



50



AG 2064 QUADRITICO

Quadrimestrale 12 fogli in carta patinata, testata rinforzata, cursore incluso.



Carta patinata 80 gr



Calendario 33 x 100 cm
Testata ca. 33 x 20 cm



40





**AG 2080
CALENDARIO
TRIMESTRALE
DA TAVOLO**

Spiralato 13 fogli carta patinata.
Planning 2020 e 2021 sul retro.



Carta patinata 100 gr



Calendario 19 x 14 cm
Spazio Stampa 19 x 4 cm



100



**AG 2081
CALENDARIO
TRIMESTRALE
DA TAVOLO**

Spiralato 13 fogli carta patinata.
Planning 2020 e 2021 sul retro.



Carta patinata 100 gr



Calendario 19 x 14 cm
Spazio Stampa 19 x 4 cm



100





RETRO



**AG 2084
TRICOLORE DA
TAVOLO**

Spiralato 13 fogli carta patinata.
Planning 2020 e 2021 sul retro.



Carta patinata 100 gr



Calendario 19 x 14 cm
Spazio Stampa 19 x 4 cm



100



**AG 2083
CALENDARIO
DA TAVOLO STYLE**

Spiralato 12 fogli + copertina carta
patinata. Planning 2020 e 2021 sul
retro.



Carta patinata 100 gr



Calendario 12,5 x 20 cm
Spazio Stampa 11 x 3 cm



100





AG 2085
CALENDARIO TRIMESTRALE
DA TAVOLO

Spiralato 13 fogli patinati. Planning 2020 e 2021 sul retro.



Carta patinata 100 gr



Calendario 19 x 14 cm
 Spazio Stampa 19 x 4 cm



100



AG 2072 PORTOGHESE DA TAVOLO

Spiralato 13 fogli carta patinata. Planning 2020 e 2021 sul retro.



Carta patinata 100 gr



Calendario 19 x 14 cm
Spazio Stampa 19 x 4 cm





100



**AG 2075
SAN PIO
CALENDARIO
DA TAVOLO**



Spiralato 13 fogli, carta patinata.
Planning 2020 e 2021 sul retro.

-  Carta patinata 100 grtt
-  Calendario 19 x 14 cm
Spazio Stampa 19 x 4 cm
-  100



**AG 2079
CITTÀ D'ITALIA
CALENDARIO
DA TAVOLO**

Spiralato 13 fogli, carta patinata.
Planning 2020 e 2021 sul retro.

-  Carta patinata 100 gr
-  Calendario 19 x 14 cm
Spazio Stampa 19 x 4 cm
-  100





**AG 2073
AUTO SPORTIVE
CALENDARIO
DA TAVOLO**

Spiralato 13 fogli, carta patinata.
Planning 2020 e 2021 sul retro.



Carta patinata 100 gr



Calendario 19 x 14 cm
Spazio Stampa 19 x 4 cm



100



**AG 2078
CANI E GATTI
CALENDARIO
DA TAVOLO**

Spiralato 13 fogli, carta patinata.
Planning 2020 e 2021 sul retro.



Carta patinata 100 gr



Calendario 19 x 14 cm
Spazio Stampa 19 x 4 cm





100



AG 2090 PLANNING MAXI



50 fogli carta uso mano.

-  Carta uso mano 80 gr
-  43x31 cm
Testata 43 x 4 cm
-  25



AG 2086 PLANNING MEDIO



50 fogli carta uso mano.

-  Carta uso mano 80 gr
-  30 x 21 cm
Testata 30 x 3 cm
-  25



AG 2087 MINI PLANNING

50 fogli carta uso mano.

-  Carta uso mano 80 gr
-  30x14,5 cm
Testata 30x3 cm
-  50

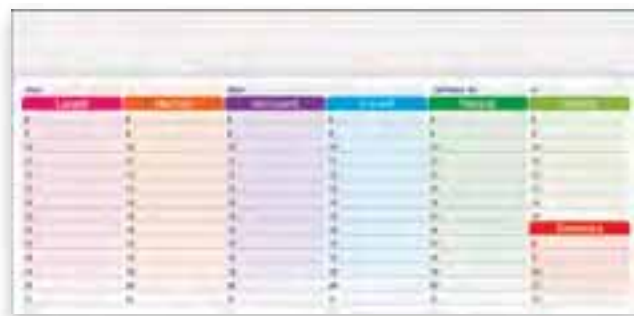

promosolution 2020|2021

**PENNE IN METALLO
PENNE IN PLASTICA
PENNE DA BANCO
MATITE
SET COLORI
ASTUCCI PORTAPENNE**





NE

SI

GR

BL



SI

NE

GR

BL



 PARKER

**AL 2134
PARKER IM**

Penna biro in ottone laccato con finiture cromate. Corredata di astuccio. Refil Blu.

 Ottone

 1

 PARKER

**AL 2138
PARKER IM**

Penna roller in ottone laccato con finiture cromate. Corredata di astuccio. Refil Nero

 Ottone

 1



NE

BL

BO

BI



 PARKER

AL 2130 PARKER JOTTER PENNA

Penna in acciaio con meccanismo a scatto. Refil blu. Confezione in astuccio.

 Acciaio

 1

 PARKER

AL 2131 PARKER JOTTER PREMIUM PORTAMINE

Portamine in acciaio con mina da 0,5 mm. Confezione in astuccio.

 Acciaio

 1

 PARKER

AL 2147 PARKER JOTTER

Penna biro "Parker Jotter" in plastica e metallo con meccanismo a scatto. Corredata di astuccio. Refil Nero

 ABS/ metallo

 1



NE

VE

BL

AZ

RO



NE

SM

BL



HUGO BOSS

**AL 2109
BIRO HUGO BOSS**

Penna biro in ottone rivestito in soft touch con finiture nero opaco. Corredata di astuccio. Refil blu.



Ottone



1

HUGO BOSS

**AL 2110
BIRO HUGO BOSS**

Penna biro in ottone rivestito in poliuretano con finiture cromate. Corredata di astuccio. Refil blu.



Ottone



1



SI

NE



HUGO BOSS

AL 2104 BIRO HUGO BOSS

Penna biro in ottone laccato con finiture silver e logo HUGO BOSS inciso sul fusto. Corredata di astuccio. Refil blu.

i Ottone

♻️ 1



HUGO BOSS

AL 2111 BIRO HUGO BOSS

Penna biro in ottone cromato. Corredata di astuccio. Refil blu.

i Ottone

♻️ 1



HUGO BOSS

AL 2112 ROLLER HUGO BOSS

Penna roller in ottone cromato. Corredata di astuccio. Refil blu.

i Ottone

♻️ 1

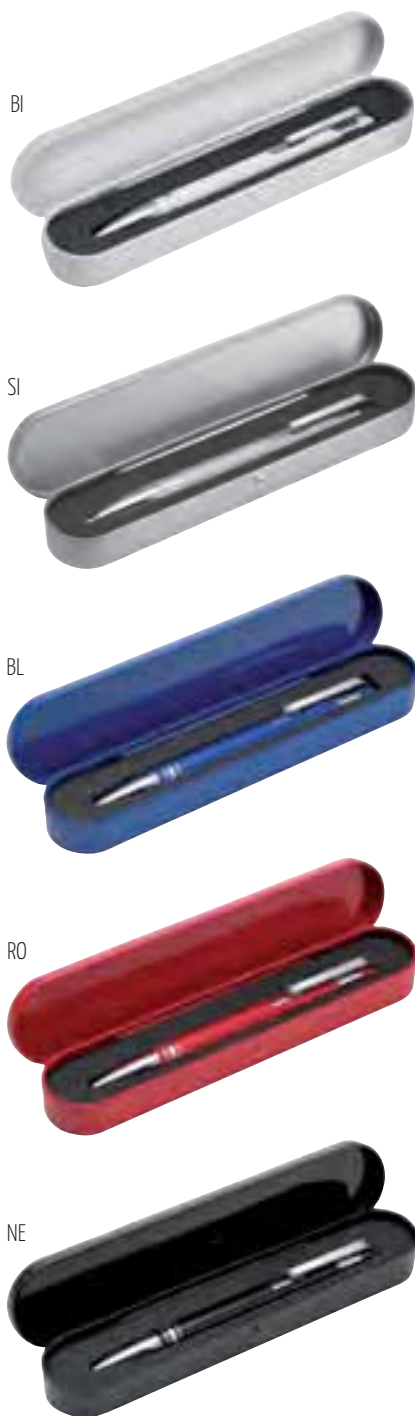

**AL 2218
VALENCIA**

Penna a sfera in alluminio, completa di astuccio, refill nero.



Alluminio



1/50



**LAVILLE®
PARIS**

**AL 2161
PENNA
MULTIFUNZIONE**

Un pratico accessorio realizzato in metallo cromato e satinato che combina 4 differenti funzioni: | Portachiavi | Penna a sfera | Puntatore "touch" | Gettone per carrello spesa | Confezionato in una prestigiosa confezione in metallo argentato



Metallo



1/50



INCIDENDO CON IL LASER ESCE IL FONDO
DELLO STESSO COLORE DELLA CLIP



RO BL AZ AR SI VE GI

AL 2200 BAHAMAS

Penna a sfera con touch, fusto in alluminio doppio strato di laccatura: primo strato nero e secondo strato dello stesso colore del touch, refill nero



Alluminio



50/500



INCIDENDO CON IL LASER ESCE IL FONDO
DELLO STESSO COLORE DELLA CLIP



SI AR BL VE RO

AL 2188 MAURITIUS

Penna in metallo con doppio strato di laccatura: primo strato nero e secondo strato dello stesso colore della clip. Refil blu.



Alluminio



50/500



SI



RO



NE



BI



RY



TOUCH



NE



BI



BL



VE



RO



AR



TOUCH

**AL 2165
TOKYO**

Penna a sfera touch in alluminio, refill blu.



Alluminio



50/500

**AL 2180
SMART**

Penna a sfera touch sottile in alluminio lucido. Refil nero.



Alluminio



50/500



BL

SI

AZ

NE

RO

VE



SI

GR

NE

BO

RO

RY

VE

AL 2154 DUBAI

Penna a sfera in alluminio con finiture argentate. Refil blu.



Alluminio



50/500

AL 2190 MANILA

Penna in alluminio con fusto verniciato e finiture nero opaco. Refil nero.



Alluminio



50/500



BO



BL



NE



RO



AR



VE



SI



SI



BL



NE



RO



VE



BO



TOUCH

**AL 2192
BREMA**

Penna a sfera in alluminio con Refil nero.



Alluminio



50/500

**AL 2195
AMBURGO**

Penna a sfera touch in alluminio. Refil nero



Alluminio



50/500



NE BL RO AR VE VM BO SI BI

**AL 2253
MONACO**

Penna a sfera in plastica con particolari in metallo. Refil nero

 Plastica e Metallo

 50/1000



AR BL NE RO VE VM BO SI BI

**AL 2251
COLONIA**

Penna a sfera touch in plastica con particolari in metallo. Refil nero

 Plastica e Metallo

 50/1000



SI

GI

AR

RO

VE

NE

BI

BL

AL 2248 LONDRA

Penna a sfera touch in plastica con clip in metallo e refill nero.



Plastica e Metallo



50/1000



TOUCH



TOUCH



NE

RO

AR

VM

VE

AZ



TOUCH



BI

NE

AR

RO

BL

VE

AL 2243 MARSIGLIA

Penna a sfera touch in plastica con impugnatura ergonomica. Refil nero



Plastica



50/1000

AL 2249 PARIGI

Penna sfera in plastica con touch. Refil nero.



Plastica



50/1000



SI



VE



BL



NE



RO

AL 2242 BOSTON

Penna sfera in plastica con touch e led interno a luce bianca, apertura a rotazione, refill blu.



Plastica



50/1000

PENNA CON LUCE LED INTERNA





AL 2245 BROOKLYN

Penna a sfera touch in plastica e metallo
con refill nero.



Plastica e Metallo



50/1000



TOUCH

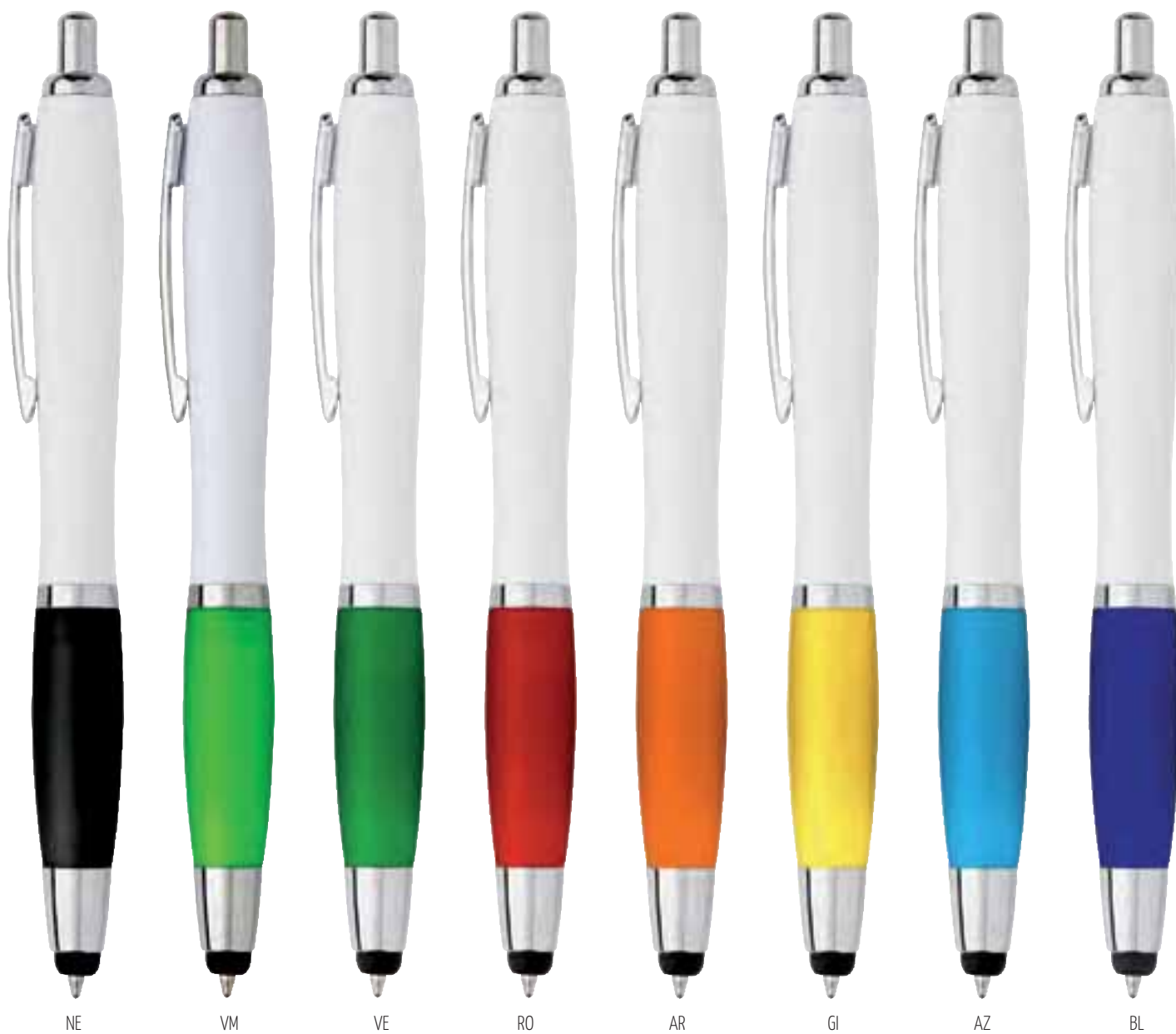

AL 2246 CUBA

Penna a sfera touch in plastica con particolari in metallo. Refil nero



Plastica e Metallo



50/1000





AL 2255 AMALFI

Penna in plastica con clip in metallo. Refil nero. Impugnatura in plastica gommata



Plastica e Metallo



50/1000



NE

VM

VE

RO

AR

GI

BL

AZ

AL 2256 POSITANO

Penna in plastica semitrasparente con clip in metallo. Refil nero. Impugnatura in plastica gommata



Plastica e Metallo



50/1000



AL 2254 NEW YORK

Penna a sfera in plastica silver con particolari in metallo. Refil nero



Plastica e Metallo



50/1000



BI



NE



VE



BL



RO



GI



NE



BL



BO



NN



BD

**AL 2235
LILIA**

Penna a sfera in plastica solid e clip in metallo, refill nero.



Plastica e Metallo



50/1000

**AL 2240
LILIA GOLD**

Penna a sfera in plastica solid e dorata, clip in metallo, Refil nero.



Plastica e Metallo



50/1000



**AL 2275
LISBONA**

Penna sfera in plastica con meccanismo a rotazione. Refil nero.



Plastica



50/1000



**AL 2276
ZURIGO**

Penna sfera in plastica con meccanismo a rotazione. Refil nero.



Plastica



50/1000



NE



BL



VE



BI



AR



RO



RO



VE



AR



BL



AZ



GI

AL 2268 MANCHESTER

Penna a scatto in plastica bianca con particolari colorati. Refil nero



Plastica



50/1000

AL 2265 MALAGA

Penna a scatto in plastica bianca con particolari colorati. Refil nero



Plastica



50/1000



BL



VE



NE



RO



AR



GI



BI



GI



AR



RO



BL



VE



NE

AL 2325 NEW JERSEY

Penna a sfera in plastica con impugnatura in gomma. Refil nero



Plastica



50/1000

AL 2310 PORTORICO

Penna a sfera in plastica con impugnatura in gomma. Refil nero



Plastica



50/1000



AL 2272 LIVERPOOL

Penna ink-gel in plastica bianca con particolari colorati, chiusura con tappo. Refil nero.



Plastica



50/1000





BL

RY

VI

RS

NE

RO

AR

GI

VM

VE

AL 2350 OSAKA

Penna in plastica. Refil Nero



Plastica



50/1000



NE



BL

RY

AZ

VE

VM

BO

RO

AR

GI

FX

RS

BI

CR

AL 2355 MITO

Penna a sfera in plastica con clip in metallo. Refil nero



Plastica e Metallo



50/1000



AL 2360 MANILA

Penna a sfera in plastica argentata e solid, refill nero.



Plastica



50/1000



AL 2260 STOCCARDA

Penna a sfera in plastica con particolari in metallo. Refil nero



Plastica



50/1000

AL 2320 CIPRO

Penna sfera con fusto in plastica con finiture cromate. Refil nero.



Plastica



50/1000



RO

NE

BL

AZ

VM

AR

AZ

BL

AR

RO

VE

VM

AL 2301 ATLANTA

Penna sfera con fusto in ABS bianco con finiture colorate. Refil nero.



Plastica



50/1000

AL 2305 FLORIDA

Penna sfera in ABS colorato con finiture bianche. Refil blu.



Plastica



50/1000



AL 2326 SANTIAGO

Penna sfera con fusto in plastica.
Refil nero.

 Plastica

 50/1000

AL 2327 VIENNA

Penna sfera con fusto in plastica.
Refil nero.

 Plastica

 50/1000



NE

AZ

AR

VE

RO

VE

AZ

BG

AR

RO

AL 2340 MADRID

Penna a sfera in cartone biodegradabile,
particolari in ABS , refill blu.



Cartone



50/1000

AL 2345 VALENCIA

Penna a sfera in bamboo biodegradabile,
particolari in ABS , refill blu.



Bamboo



50/1000

**AL 2368
STILOFORO**

con penna su base con piedini, cordino a spirale. Refil nero.



Plastica



16x6,5 cm - Ø 4 cm



50/200

**AL 2370
STILOFORO**

Con penna in plastica, cordino a spirale. Refil blu.



Plastica



16,3x5,4x4 cm



20/120



AL 2373 PENNA

Penna a sfera siringa con refill nero.



Plastica



13 cm - Ø 1 cm



50/1000

RO



BL



VE



AL 2250 BERLINO

Mini penna a sfera touch con portachiavi in plastica refill nero.



Plastica



8 cm



50/1000



RO

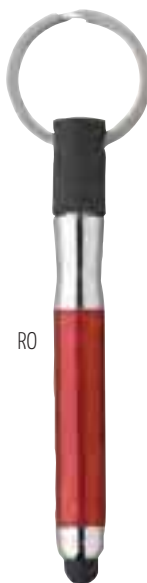

NE

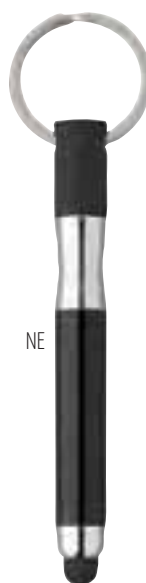

SI



BL





NE SI BI RO GI VE BL



AR BI BL RO VE

**AL 2375
MATITA**

Matita in legno colorato con gomma



Legno



100/2000

**AL 2378
MATITA**

Matita in legno naturale con gomma



Legno



100/2000

AL 2381 MATITA

ALL BLACK



Legno



50/1000



AL 2382 MATITA

ALL BLACK con gomma



Legno



60/600



AL 2376 MATITA

Matita con fusto nero e cristallino colorato in punta.



Legno



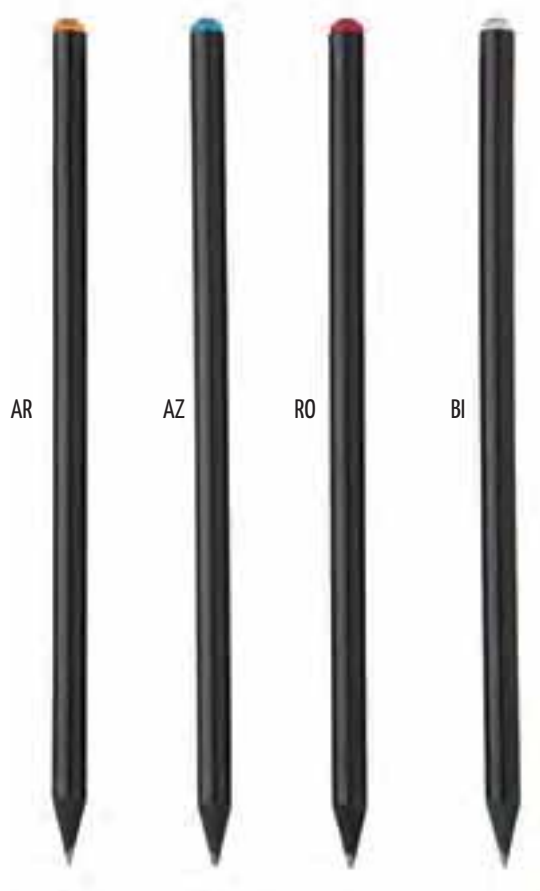

100/1000





**AL 2505
SET 12 MATITE**

colorate, in astuccio cilindrico in cartone, coperchio in plastica con temperamatite.

-  Legno/ Carta
-  Ø 3,5 x 10,7 cm
-  20/200



**AL 2506
SET 6 MATITE**

colorate, in astuccio cilindrico in cartone, coperchio in plastica con temperamatite.

-  Legno/ Carta
-  Ø 2,7 x 10,3 cm
-  48/480



**AL 2388
SET DISEGNO**

Set 10 matite in legno con righello e temperamatite e con libricino da colorare.

-  Legno/ Carta / Plastica
-  18X7,5X1,2 cm
-  50/200

**AL 2389
SET 6 MATITE**

Set 6 matite corte colorate, confezione in cartoncino.

-  Legno/ Carta
-  4,5X9x0,9 cm
-  48/960





AL 2410 SET ARTE

56 pezzi, pennarelli, acquarelli, matite, pastelli, temperamatite e gomma, in cofanetto.



Plastica/ Carta



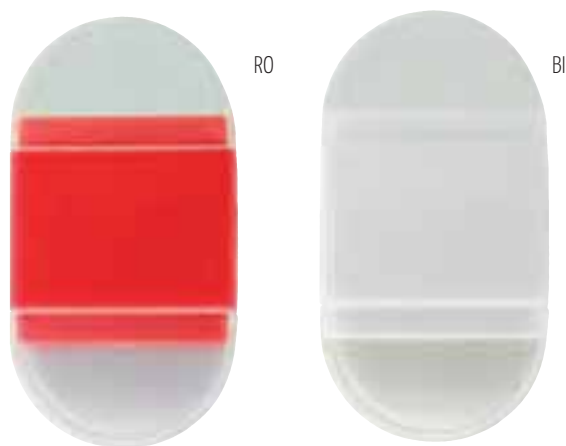

1/12



**AL 2424
SET ARTE**

Astuccio portapenne con chiusura lampo.

-  Poliestere 420D
-  20,5 x 9,5 x 0,8 cm
-  50/200

**AL 2431
GOMMA**

Gomma con temperamatite.

-  Plastica
-  6,4 x 3,4 x 1,7 cm
-  24/240

promosolution2020|2021

**ACCENDINI IN PLASTICA
ACCENDINI IN METALLO
ACCENDIGAS
POSACENERE**



**AM 2515
ACCENDINO**

Piezo in plastica, ricaricabile.

-  Plastica
-  8x2,4 cm
-  50/1000



RO

GI



AR



BL



BI



NE



VM



VE



**AM 2514
ACCENDINO**

Piezo in plastica, ricaricabile.

-  Plastica
-  8x2,4 cm
-  50/1000



NE

OR



SI



BI



GI



RY



RO



**AM 2516
ACCENDINO**

Piezo in plastica, ricaricabile.

-  Plastica
-  8x2,5 cm
-  50/1000



RO

AR



BL



NE



VE



AM 2518 ACCENDINO

A pietra focaia in plastica neon.
confezione da 50 pz. in colori assortiti.



-  Plastica
-  8x2,3 cm
-  50/1000



ACCENDINI

AM 2520 ACCENDINO

A pietra focaia in plastica.

-  Plastica
-  8x2,4 cm.
-  50/1000



AM 2519 ACCENDINO APRIBOTTIGLIE

In plastica a pietra.

-  Plastica
-  9x2,4 cm
-  50/1000



**AM 2525
ACCENDINO**

Piezo in plastica ricaricabile.

 Plastica

 6,4x3,5cm

 30/300



**AM 2524
ACCENDINO**

Accendino in plastica ricaricabile.

 Plastica

 6,5 x 3,5 cm

 30/600



**AM 2526
ACCENDINO**

In plastica solid ricaricabile.

 Plastica

 8x3 cm

 25/250



**AM 2527
ACCENDINO**

In plastica effetto gommato ricaricabile.

 Plastica gommata

 8x3 cm

 25/250



**AM 2530
ACCENDINO**

In plastica solid FLUO ricaricabile.
confezione da 25 pz. in colori assortiti.

 Plastica Fluo

 8x3 cm

 25/250



**AM 2533
ACCENDINO**

In plastica FLUO effetto gommato
ricaricabile. confezione da 25 pz. in colori
assortiti.

 Plastica Fluo gommata

 9x2,4 cm

 25/250





BI



NE



RO



BI



GI

**AM 2540
ACCENDIGAS**

In plastica ricaricabile.



Plastica



10,5x3,2 cm



28/280

**AM 2523
ACCENDINO MAXI**

Piezo in plastica ricaricabile



Plastica



4 x 11 cm



20/100

AM 2552 ACCENDINO

Tascabile con astuccio in cartoncino.

 Metallo

 5,6x3,6 cm

 12/120



AM 2558 ACCENDINO

Tascabile in metallo lucido con astuccio in cartoncino.

 Metallo

 5,6x3,6 cm

 12/120



AM 2556 ACCENDINO

Accendino in plastica con fiamma turbo antivento.

 Plastica



 6,6 X 4 X 1,9 cm

 10/100





**AM 2565
POSACENERE
TASCABILE**

In PVC, Richiudibile con bottone.

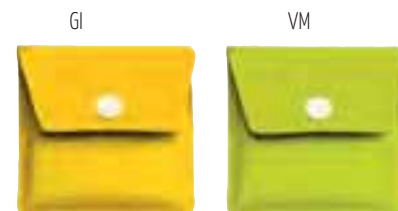
-  PVC
-  8 x 8 cm
-  50/500





**AM 2569
POSACENERE IN
VETRO**

-  Vetro
-  Ø 10,2 x H 3,3 cm
-  12/72



**AM 2562
POSACENERE
IN METALLO**

-  Metallo
-  Ø 14 x H 4,5 cm
-  6/24





promosolution2020|2021

**PORTACHIAVI IN METALLO
PORTACHIAVI IN SIMILPELLE
PORTACHIAVI CON LED
PORTACHIAVI CON GETTONE
LANYARD
PORTABADGE
BRACCIALETTI**



**AN 2610
PORTACHIAVI
GATTO**



In metallo e lacca rossa, retro liscio per promo. In astuccio.

-  Metallo
-  4x4 cm
-  50/200



**AN 2622
PORTACHIAVI
CASA**



in metallo a forma di casa. Confezione in astuccio.

-  Metallo
-  7,1x4,8 cm
-  50/200



**AN 2602
PORTACHIAVI
QUADRIFOGLIO**



In metallo e lacca verde, retro liscio per promo. In astuccio.

-  Metallo
-  3,5x4 cm
-  50/300



**AN 2623
PORTACHIAVI**



Portachiavi camion in metallo rivestito di nickel lucido.

-  Metallo
-  5,4x2,8 cm
-  50/200



**AN 2624
PORTACHIAVI
AUTO**



In metallo a forma di auto. Confezione in astuccio.

-  Metallo
-  6x4,3 cm
-  50/200



**AN 2710
PORTACHIAVI**



In metallo e tessuto. Confezione in astuccio.

-  Metallo
-  2,2 x 8,5 cm
-  50/200



AN 2648 PORTACHIAVI VIP



rettangolare in metallo con superficie
liscia per incisione laser.

-  Metallo
-  3,5x2 cm
-  50/200



AN 2640 PORTACHIAVI CERCHIO



In metallo. Confezione In astuccio.

-  Metallo
-  Ø 3,2 cm - Ø interno 2,6 cm
-  50/200



AN 2631 PORTACHIAVI OVALE



In metallo a forma ovale. Confezione In
astuccio.

-  Metallo
-  5,5x2,5 cm
-  50/200



AN 2712 PORTACHIAVI



Portachiavi rettangolare con placca in
metallo colorata e fascetta in poliestere
nero. Confezione in astuccio.

-  Metallo
-  4,1x2,5 cm
-  50/200



AN 2632 PORTACHIAVI RETTANGOLO



In metallo a forma di rettangolo.
Confezione in astuccio.

-  Metallo
-  4,5x2,5 cm
-  50/200



PORTACHIAVI VIP

In metallo e caucciù con marchi auto pressofusi.

-  Metallo
-  2x2 cm
-  10/50



AN 0102

Retro inciso con laser

AN 0107



AN 0124

AN 0119



AN 0133

AN 0115



AN 0114

AN 0134



AN 0127

AN 0132



AN 0123

AN 0108



AN 0104

AN 0105



AN 0105

AN 0125



AN 0125

AN 0126



AN 0126

AN 0117



AN 0117

AN 0118



AN 0118

AN 0116



AN 0116

AN 0112



AN 0112

AN 0111



AN 0111

AN 0106



AN 0106

AN 0129



AN 0129

AN 0113



AN 0113

AN 0128



AN 0128

AN 0110



AN 0110

AN 0109



AN 0109

AN 0103



AN 0103

AN 0130



AN 0130

AN 0120



AN 0120

AN 0136



AN 0136

AN 0101



AN 0101

AN 0102



AN 0102

AN 0105



AN 0105

AN 0106



AN 0106

AN 0107



AN 0107



AN 0108



AN 0108

PORTACHIAVI VIP

In metallo e con marchi auto pressofusi.

-  Metallo
-  3,5x2 cm
-  10/50



AN 0148

Retro inciso con laser

AN 0156



AN 0140



AN 0141



AN 0167



AN 0151



AN 0168



AN 0145



AN 0150



AN 0162



AN 0174



AN 0169



AN 0153



AN 0155



AN 0173



AN 0161



AN 0152



AN 0142



AN 0143



AN 0154



AN 0164



AN 0147



AN 0163



AN 0159



AN 0158



AN 0144



AN 0166



AN 0160



AN 0165



AN 0157



AN 2812 PORTACHIAVI T-SHIRT



in plastica trasparente con incastro etichetta per stampa promo. Fornito aperto.

-  Plastica
-  7,6 x 0,7 cm.
-  100/500



AN 2817 REFIL



In carta per portachiavi, 12 pezzi prefustellati su foglio f.to A4

-  Carta
-  A4
-  12



AN 2813 PORTACHIAVI CERCHIO



in plastica trasparente con incastro etichetta per stampa promo. Fornito aperto.

-  Plastica
-  Ø 4,5 x 0,7 cm
-  100/500



AN 2815 REFIL

In carta per portachiavi, 12 pezzi prefustellati su foglio f.to A4

-  Carta
-  A4
-  12



AN 2814 PORTACHIAVI RETTANGOLO



in plastica trasparente con incastro etichetta per stampa promo. Fornito aperto.

-  Plastica
-  9 x 4,2 x 0,6 cm.
-  100/500



AN 2816 REFIL

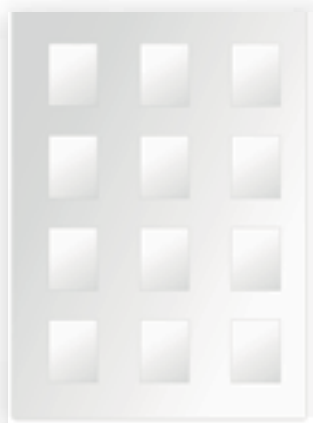

In carta per portachiavi, 12 pezzi prefustellati su foglio f.to A4

-  Carta
-  A4
-  12



AN 2831 PORTACHIAVI



Con luce e gettone per carrello, in plastica. Confezione in polybag.

-  ABS
-  3 x 7 x 0,7 cm
-  50/500



AN 2832 PORTACHIAVI



Rettangolare con luce in plastica. Confezione in polybag.

-  ABS
-  2,5 x 6 x 0,7 cm
-  100/500



AN 2833 PORTACHIAVI



Portachiavi in ABS a forma di lampadina, anello in acciaio.

-  ABS
-  6,0 x 3,7 x 1,0 cm
-  100/500



**AP 2992
PORTACHIAVI
TOUCH CAPACITIVO**

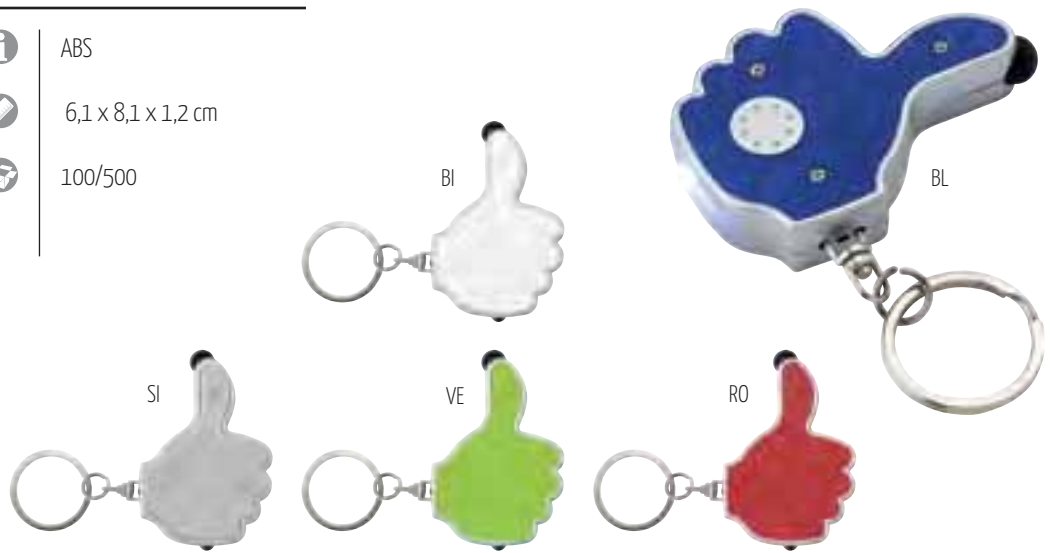

Portachiavi capacitivo compatibile su schermi touch, con luce LED bianca, batterie incluse.

-  ABS
-  6,1 x 8,1 x 1,2 cm
-  100/500



**AP 3013
PORTACHIAVI
CAPACITIVO**



Portachiavi capacitivo compatibile su schermi touch, roteante, funzione pulisci schermo, in plastica.

-  PVC
-  10x1,8x0,8 cm
-  100/500



**AN 2760
PORTACHIAVI**

Portachiavi in similpelle e metallo.

-  Similpelle
-  10x3,5 cm.
-  50/200



AN 2834 PORTACHIAVI

in plastica con gettone per carrello con led.

 ABS

 7 x 2,5 cm.

 50/500



VE

AL 2250 BERLINO

Mini penna a sfera touch con portachivi in plastica refill nero.

 Plastica

 8 cm

 50/500



SI

NE

RO

BL

AN 2836 PORTACHIAVI

Portachivi con il nastro di misurazione, livella, piccola penna a sfera refill nero.

 ABS

 4,3 x 4,3 x 1 cm

 50/500



BI

BL

NE

RO

**AN 2845
LANYARD**

Collarino da collo in poliestere con sgancio di sicurezza, sgancio portachiavi e moschettone in metallo.



Poliestere



82 x 2,5 cm ca.



50/500



**AN 2850
LANYARD**

Collarino da collo in poliestere con sgancio di sicurezza, sgancio portachiavi e moschettone in metallo.



Poliestere



82 x 2 cm





50/500





AN 2846 LANYARD

Con portabadge in pvc incluso.

-  Poliestere/PVC
-  Portabadge: 9,5x5,4 cm.
Lanyard: 47 cm
-  50/500





AN 2849 PORTABADGE

-  PVC trasparente
-  10x8 cm
-  10/100



AN 2848 PORTABADGE

-  PVC trasparente
-  7,5x12,5 cm
-  10/100



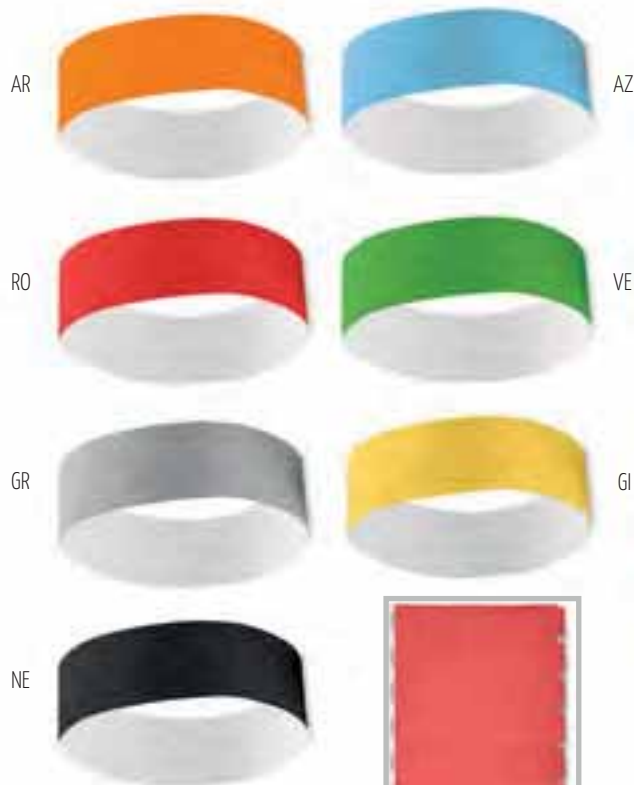



Fornito a strisce da 10 pz.



AN 2896 BRACCIALETTO

Braccialetto in Tyvek con chiusura adesiva.

-  Tyvek
-  24,5 x 1,9 cm
-  100/500

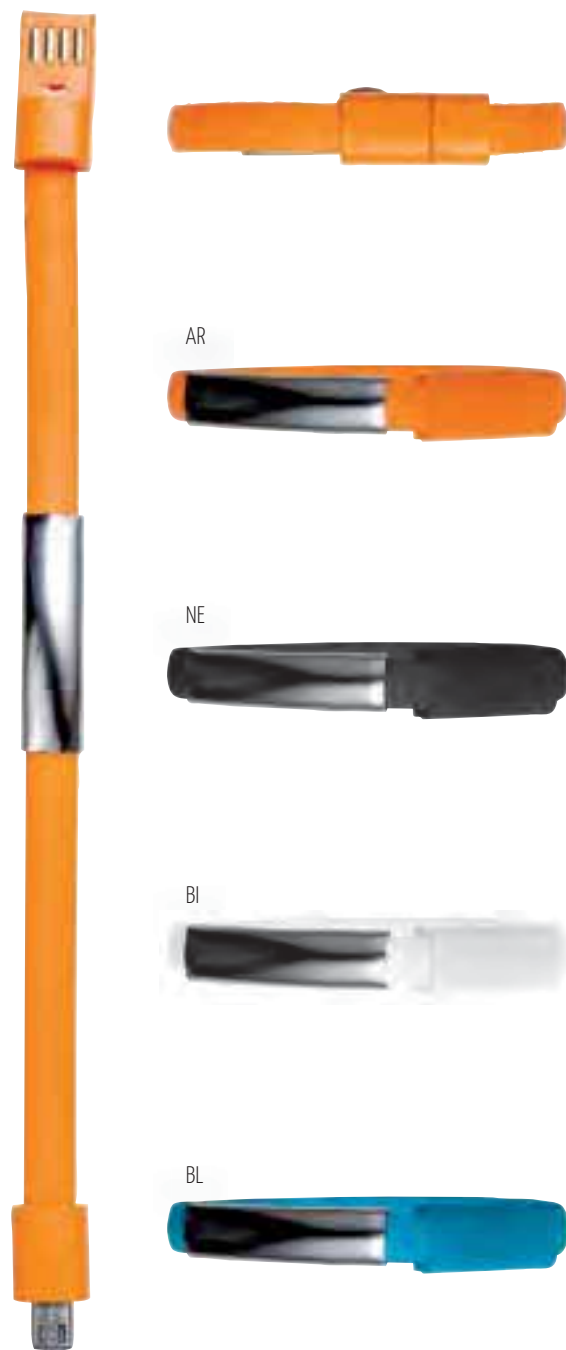

AN 2895 BRACCIALETTA

Braccialetto in silicone con USB, utilizzabile per la ricarica di vari devise in commercio tramite la micro USB, placca in metallo per la personalizzazione.

-  Silicone / Metallo
-  8,2 x 2 cm
-  100/500

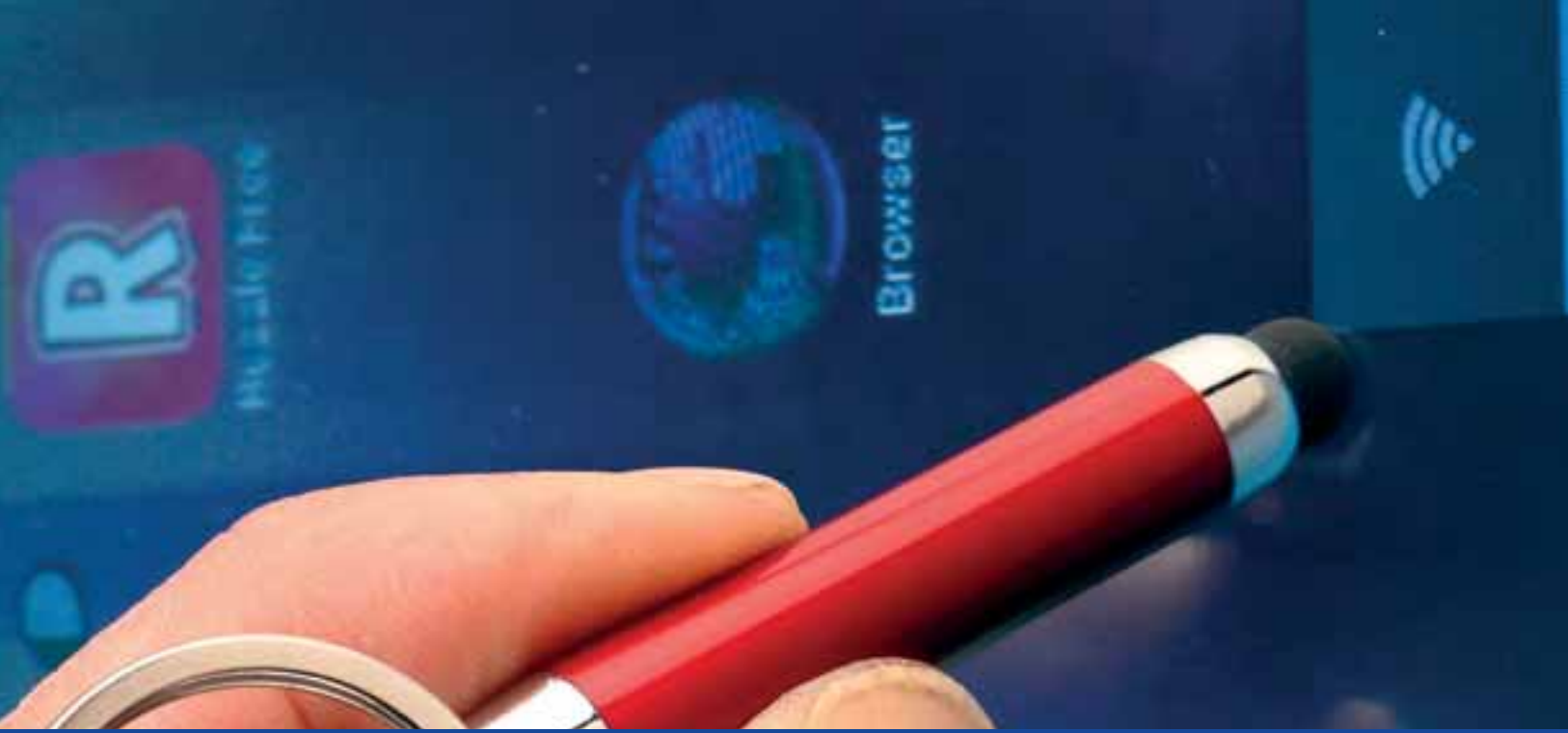

promosolution2020|2021

AP 2910 SPEAKER WIRELESS

Speaker wireless da doccia in plastica (2 watt), water proof, dotato di ventosa per posizionarlo su superfici lisce, perfetto per rispondere alle chiamate in modalità vivavoce oppure per ascoltare musica.



ABS



Ø 8 x H 5 cm



1/60



NE



BI

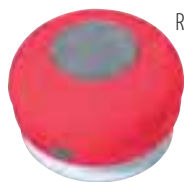

RO

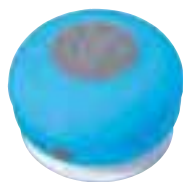

AZ

AP 2922 SPEAKER WIRELESS

Speaker wireless in plastica, batteria 150mA, può essere usato per il controllo da remoto della fotocamera dello smartphone, comprende cavo per la ricarica USB 35 cm circa.



ABS



2,7 x 2,7 x 2,9 cm



1/100



NE



AZ



BI



AP 2924 SPEAKER BLUETOOTH

Altoparlante bluetooth potenza musicale 3 watt, con versione Bluetooth 4.1, slot per schede micro-SD, incluso cavo di ricarica (da USB a mini-USB e 3,5 mm connettore line-in), riproduce MP3, con funzione vivavoce, batteria ricaricabile integrata con 450 mAh, tempo d'uso: circa 5 ore, tempo di ricarica: circa 2 ore, raggio d'azione circa 10 m, fondo gommato per una presa sicura.



ABS/ Metallo/ Gomma



Ø 5,8 x 5 cm



1/50



BI



NE



RO



BL

AP 2915 SPEAKER WIRELESS

Speaker con batteria al litio ricaricabile da 450 mAh, 3W. parte anteriore in tessuto e finitura in gomma, include slot per scheda TF, porte USB ed AUX (3,5 mm), quattro pulsanti per controllo funzioni, cavo per la ricarica USB.



ABS/ Lino



7,0 x 7,0 x 3,5 cm



10/100



NE

AZ

GR

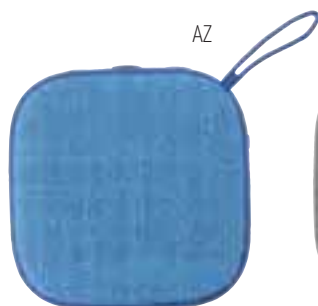

AP 2906 CASSE SPEAKER

Casse speaker in ABS, forma rotonda, finitura opaca, con cavo per smartphones/tablets.



ABS



Ø 7,5 cm - Vol. 0,813 cdm³



1/50



**AP 2979
POWERBANK**

Powerbank con batteria d'emergenza a litio, capacità di 4.000mAh, input 5V/1A, output 5V/1A, indicatore di ricarica, include porta USB, micro USB.



Alluminio



11,0 x 6,8 x 1,0 cm



1/25



**AP 2977
POWERBANK**

Powerbank con una capacità di 5000mAh, un ingresso di 5V/1A e uscita di 1A/2.1A/5V. Entrambi i lati sono lucidi con un bordo color argento. Include 5 luci di indicazione di alimentazione di LED blue e un cavo USB/micro USB bianco (circa 32 cm.), batteria agli ioni di litio ad alte prestazioni.



ABS



12,2 x 7,2 x 1,1 cm



1/25

BI

NE



**AP 2981
POWERBANK**

Powerbank con batteria d'emergenza ai polimeri di litio, capacità di 4000mAh, input di 5V/A, output di 1A/5V, include indicatore di carica digitale a cifre rosse nell'angolo superiore destro, cavo USB / Micro USB (32cm circa).



Alluminio



7,0 x 12,0 x 0,9 cm





1/25



AP 2967 POWERBANK



Adatto per smartphone, iPhone ed apparecchi USB, incl. cavo USB con presa USB micro (lungo: ca. 25 cm), ingresso alimentazione: 5V, potenza in uscita: 5V/1000 mA, tempo di ricarica: circa 4 ore, capacità: 2200 mAh, batteria agli ioni di litio ad alte prestazioni. Cavo non incluso.

-  Plastica ABS
-  9,8x2,4x2,1 cm
-  8/80



AP 2968 POWERBANK



Powerbank adatto per i più comuni smartphone e apparecchi USB, cavo di ricarica USB con micro presa USB (lungo ca. 30 cm), potenza in entrata e uscita: 5V/1 A, capacità: 4.000 mAh, potente batteria ricaricabile.

-  ABS
-  9,7 × 4,5 × 2,3 cm
-  1/25



AP 2936 CARICABATTERIE PER AUTO



Con ingresso USB, input 12-24V, output 5V/800mAh. Dim.

-  ABS/ Metallo
-  5,5 × 2,4 cm
-  100/600



AP 2972 POWERBANK WIRELESS

Base di ricarica wireless per smartphone. La ricarica avviene collega il dispositivo ad una porta usb e posiziona lo smartphone sulla superficie. Compatibile con modelli con tecnologia di ricarica wireless. DC5V / 1.0A. Cavo incluso. Fornito in astuccio.

-  ABS
-  Ø7 × 1 cm
-  1/50

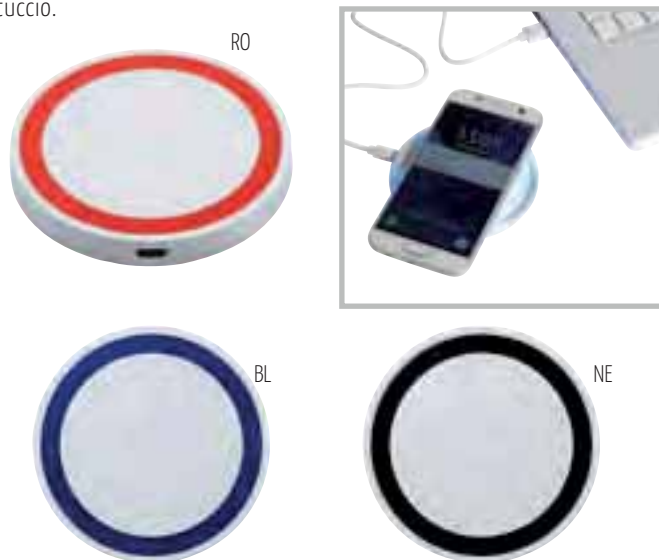

**AP 2932
AURICOLARI
WIRELESS**

Auricolari wireless, funzione di risposta alle chiamate, lunghezza cavo circa 68 cm, dotato di cavo per la ricarica circa 30 cm, in comoda custodia.



ABS



8,0 x 3,5 cm



1/50

NE



BI



**AP 2934
AURICOLARI
WIRELESS**

Auricolari wireless, funzione di risposta alle chiamate, lunghezza cavo 51 cm circa, ricarica tramite USB, moschettone, in comodo astuccio.



ABS



10,0 x 3,0 x 3,0 cm



10/100



AZ

RO



**AP 2927
AURICOLARI
WIRWLESS**

Auricolari wireless Bluetooth 5.0 con custodia di ricarica. Elegante finitura bianco lucido. Pannello di controllo con tecnologia touch integrata nell'auricolare. Funzione vivavoce. Custodia con batteria ricaricabile e coperchio magnetizzato. Cavo incluso. Fornito in astuccio.



ABS



6,8x2,2x4,5 cm



1/50



**AP 2929
AURICOLARI
IN-EAR MUSIC**



Auricolari con presa da 3,5 mm, cavo lungo ca. 117 cm, in custodia dal colore abbinato.

-  Plastica
-  Ø 5,4 x 2,1 cm
-  10/100



**AP 2928
AURICOLARI**



Auricolari con supporto per tablet e smartphone, in plastica ed in tinta colore, lunghezza cavo 108 cm circa.

-  ABS
-  9,0 x 4,0 cm
-  10/80



**AP 2930
AURICOLARI**



Kit Auricolari compatibili con vari device, jack ingresso 3,5 mm, con due gommini supplementari, cavo circa 100 cm, in confezione trasparente.

-  ABS
-  6,9 x 6,9 x 1,8 cm
-  10/50



**AP 2931
AURICOLARI**



Auricolari colorati, lunghezza cavo circa 103 cm, custodia ovale in ABS in tinta colore.

-  ABS
-  7,2 x 2,4 x 1,3 cm
-  100/500



**AP 2989
8 GB USB**

Pendrives Rotate da 8 GB. Maggior protezione grazie al meccanismo girevole. Laccetto e astuccio inclusi.

-  ABS/ Metallo
-  5,5x1,5x1 cm
-  1/50

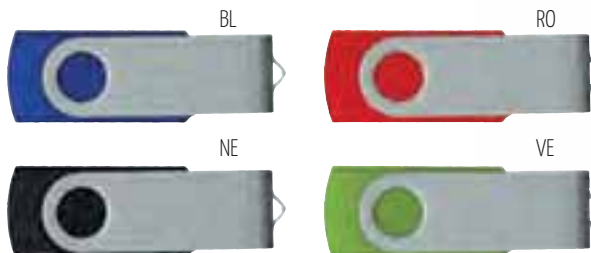

**AP 2988
16 GB USB**

Pendrives Rotate da 16 GB. Maggior protezione grazie al meccanismo girevole. Laccetto e astuccio inclusi.



**AP 2993
16 GB USB**



Pendrives Portachiavi USB in metallo e pelle con chiusura magnetica.

-  Pelle/ Metallo
-  16x10,4x3,2
-  1/50



**AP 2994
8 GB USB**



Card in pvc con Pendrive USB ripiegabile, adatta per stampa UV.

-  PVC
-  8,5 x 5,5 cm
-  1/50



AP 3000 SUPPORTO PER CELLULARE

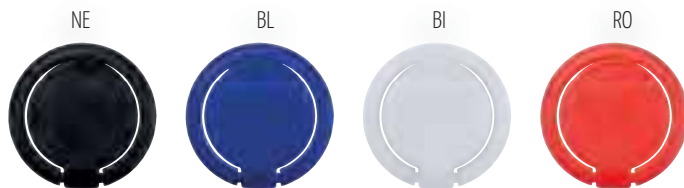

Supporto per cellulare multifunzione.
Anello girevole a 360°. Moneta trolley
integrata. Adesivo.

-  ABS
-  0,6 x Ø3,3 cm
-  200/1000



AP 3009 PORTACHIAVI CAVO RICARICA

Cavo caricabatterie con portachiavi 3 in 1.
Corpo in ABS design piatto ideale per la
marcatura. Connessione Micro USB, Tipo
C e Lightning.

-  ABS
-  8,5x3,4x0,5 cm
-  100/500

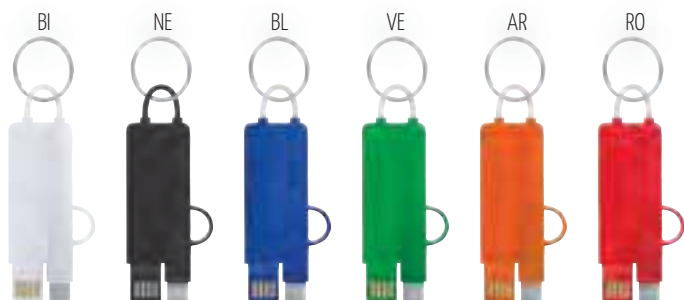

AN 2895 BRACCIALETTO



Braccialetto in silicone con USB,
utilizzabile per la ricarica di vari devise in
commercio tramite la micro USB, placca
in metallo per la personalizzazione.

-  Silicone/ Metallo
-  8,2 x 2 cm
-  100/500



**AP 2992
PORTACHIAVI
TOUCH CAPACITIVO**

Portachiavi capacitivo compatibile su schermi touch, con luce LED bianca, batterie incluse.

-  ABS
-  6,1 x 8,1 x 1,2 cm
-  100/500

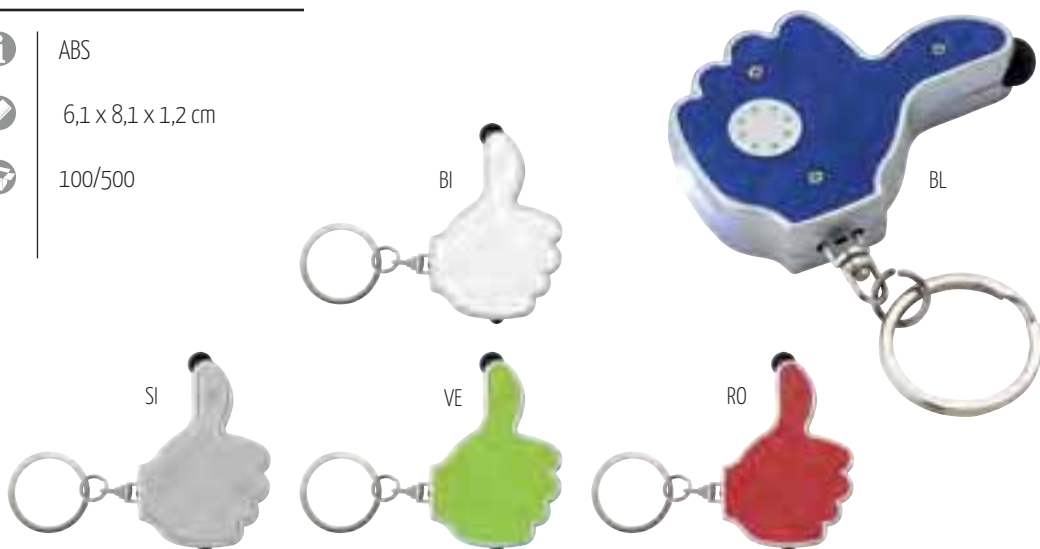

**AL 2250
MINI PENNA TOUCH**



Mini penna a sfera touch con portachiavi in plastica refil nero.

-  Plastica
-  8 cm
-  50/1000



**AP 3013
PORTACHIAVI
CAPACITIVO**

Portachiavi capacitivo compatibile su schermi touch, roteante, funzione pulisci schermo, in plastica.

-  PVC
-  10x1,8x0,8 cm
-  100/500



promosolution 2020|2021

**OROLOGI DA PARETE
PORTAPENNE
CALCOLATRICI
TAPPETINO MOUSE**



BL



RO



BI



AP 3078
OROLOGIO DA PARETE

Orologio in plastica con numeri in 3D. Confezione in astuccio.



Plastica/Vetro



Ø 30,3 x 4,8 cm



10

AP 3076
OROLOGIO DA
PARETE

Orologio in plastica con cornice
facilmente removibile.



Plastica/Vetro



29x5,5 cm



10

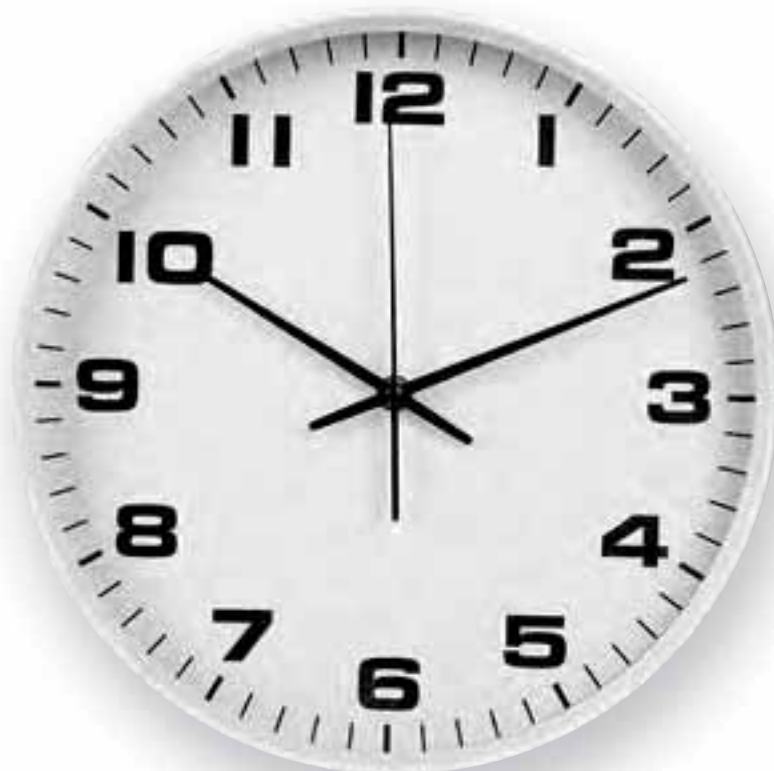

AP 3077
OROLOGIO DA
PARETE

Orologio con cornice in alluminio
facilmente removibile. Quadrante
con funzione temperatura e umidità.



Plastica/Vetro



30x2 cm



10



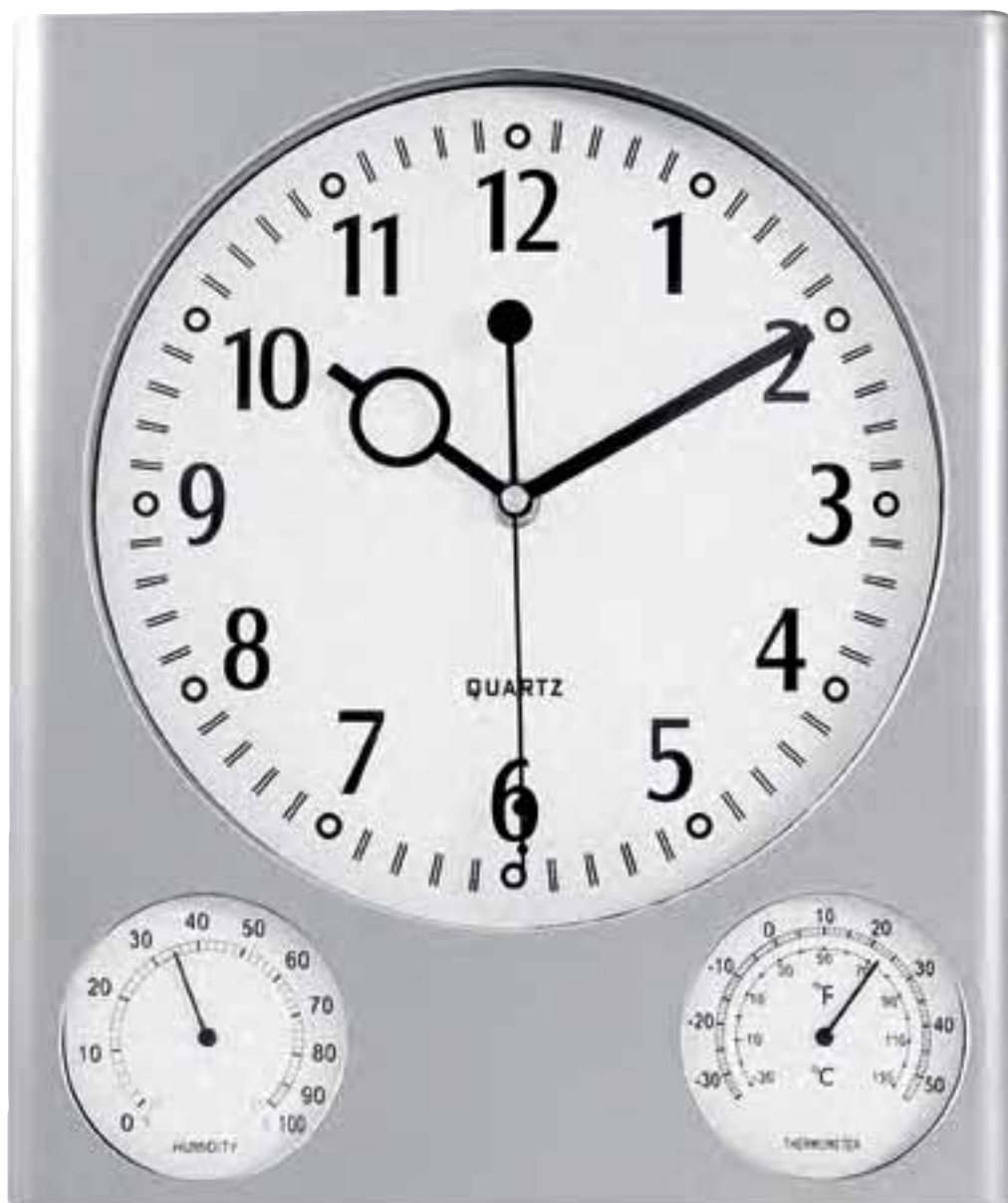

AP 3080 WEATHER CLOCK

Orologio da parete multifunzione.
Funzioni di orologio, igrometro e
termometro.



Plastica/Vetro



27,5x32x2,7



10



AP 3079 OROLOGIO DA PARETE

Orologio rettangolare con doppio quadrante estraibile per facile personalizzazione. Confezione in astuccio.



Plastica





23x33 cm



10/50

**AP 3070
PORTAPENNE**



Portapenne da tavolo con orologio, funzione sveglia, calendario e termometro, batterie incluse.

-  ABS/ Acrilico/ LCD
-  5,5 x 10,5 x 12,0 cm
-  10/40



**AP 3071
PORTAPENNE**



Portapenne in plastica bianca.

-  ABS
-  8,2x8,2x10,2 cm
-  10/50



**AP 3072
PORTAPENNE**

Portapenne in plastica bianca con copertura trasparente ad incastro adatta a contenere foglio bianco per la personalizzazione.

-  ABS
-  8,2x8,2x10,2 cm
-  10/50



AP 3002 PORTAPENNA/ SMARTPHONE

Supporto portapenna / smartphone magnetico in ABS, include penna a sfera refill blu. Fornito in confezione regalo.



ABS



14,5x8,8x1,5 cm



10/50



AP 3005 PORTAPENNE

Portapenne in plastica con luce led e supporto porta cellulare.



ABS



6,7x6,7x8 cm



1/20



BL

RO



**AP 3044
TAPPETINO MOUSE**



Stampa sublimatica.

-  Poliestere/ Silicone
-  19 x 23 cm
-  100/400



**AP 3053
DISPENSER**



Dispenser nastro adesivo. In ABS. Scotch incluso. Completa di astuccio.

-  ABS
-  13x7,1x5,4 cm
-  1/20



**AP 3004
CALCOLATRICE**

Calcolatrice 8 cifre, alimentazione a batteria e solare. Batteria inclusa.

-  ABS/ LCD/ Vetro
-  19,5x10,5x3,7 cm
-  1/25



SI



BI



NE

promosolution2020|2021

SHOPPER IN TNT
SHOPPER IN COTONE
SHOPPER IN PPL
SHOPPER RICHIUDIBILI





AQ 4020
COTTON 130 GR

Borsa da shopping in cotone.
Manici Lunghi (cm.1,5x60).



Cotone - 130 gr/mq



38x42cm



50/200



AQ 4031 COTTON 130 GR

Borsa in cotone con Manici Lunghi (cm.1,5x60).



Cotone - 130 gr/mq



38 x 42 cm



50/250

AQ 4021 COTTON 130 GR

Borsa in cotone con Manici corti.



Cotone - 130 gr/mq



38 x 42 cm



50/200

AQ 4032 COTTON 180 GR

Borsa in cotone con Manici Lunghi (cm.1,5x60).



Cotone - 180 gr/mq



38 x 42 cm



40/200



AR



NE



RO



BL



VE



AQ 4033
COTTON 135 GR

Shopper in cotone naturale con manici lunghi colorati.



Cotone - 135 gr/mq



38x42cm



50/200

AR



NE



RO



VE



BL



AQ 4036
COTTON 180 GR

Shopper in cotone naturale con soffietto e manici lunghi colorati.



Cotone - 180 gr/mq



38x42x8cm



50/200

RY



AQ 4025
TNT 38x40x10

Shopper in tnt con due manici lunghi.



TNT - 80 g/mq



38X40X10 cm



20/200



BL



SHOPPER



AQ 4030
TNT 45x42x15

Borsa da shopping con soffierto.



TNT - 80 g/mq



45 x 42 x 15 cm



20/200



AQ 4010
TNT 38x42x10

Borsa da shopping bicolore con soffietto.
Materiale: tessuto non tessuto.



TNT - 80 g/mq



38 X 42 X 10 cm



50/200



RY



BI



RO





AR



VE

AQ 4035
TNT 30x40x20

Borsa da shopping in Tnt richiudibile.
Chiusura con bottone.

-  TNT - 80gr/mq
-  34 x 40 x 20 cm
-  25/100

GI



BL



AZ



RO





VE



AQ 4026
TNT 40X47,5

Borsa da shopping in TNT richiudibile.

-  TNT - 80 gr/mq
-  40X47,5 cm
-  50/150



VI



BI



AR



GI



RO



BG

**AQ 4005
TNT 40x50**

Shopper in tnt richiudibile con coulisse,
doppio manico, doppia tasca esterna.



TNT - 80 gr/mq



40 x 50 cm



10/120



FX



NE



BI



VE



BL



AZ



RO





GI



AQ 4022
TNT 45x37

Borsa da Shopping con manici lunghi.

-  TNT - 80 gr/mq
-  45x37 cm
-  100/300



VE



RO



AR



GI



BI



NE



BL



RY

AQ 4023
TNT 38x42

Borsa da Shopping con manici lunghi.



TNT - 80 gr/mq



38 x 42 cm



20/200



OR



SI



RO



**AQ 4040
LAMINATO 38x36**

Borsa Shopper in tnt laminato con due manici lunghi.



TNT - Laminato



38 x 36 cm



10/100



GR





BL



**AQ 4012
TNT 45x35**

Borsa in tnt goffrato.

-  TNT Goffrato
-  45 x 35 cm
-  100/300



BG

GR



BI



RO



BL



BO



**AQ 4019
TNT 21x25**



Shopper in tnt con doppio manico.

-  TNT goffrato
-  21 x 25 cm
-  100/300



AQ 4016
TNT 32x25

Borsa in tnt gofrato con soffietto.

-  TNT - Goffrato
-  32 x 25 x 25 cm
-  100/300



BG



AR



FX



VE



AQ 4018
TNT 50x40

Borsa in tnt goffrato con soffierto.



TNT Goffrato



50 x 40 x 22 cm



120/360



AQ 4054
PPL 25x18x10

Shopper in polipropilene effetto jeans.



PPL



25 x 18x10cm



10/100

AQ 4055
PPL 52x37x20

Shopper in polipropilene con doppio manico lungo, richiudibile con velcro.



PPL



52x37x20cm





20/120



AQ 4045
PPL 40X33X20

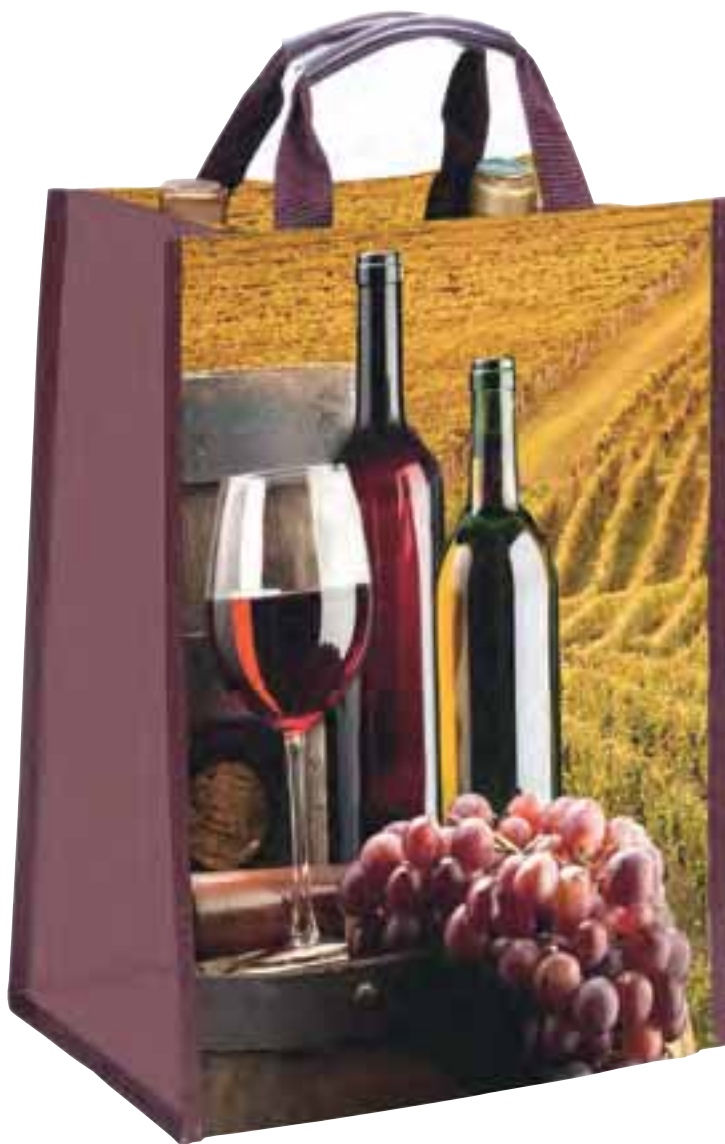

Borsa da shopping in Polipropilene.
chiusura con bottoncino.

-  PPL
-  40X33X20 cm
-  50/100





**AR 4061
PORTABOTTIGLIE**

Borsa portabottiglia in tnt, con soffierto alla base e manico fustellatio

-  TNT - 80 gr/mq
-  17x40x10 cm
-  100/500

**AQ 4056
BORSA WINE**

Borsa porta 4 bottiglie in polipropilene.

-  Polipropilene
-  37x21x10,5 cm
-  10/100

promosolution2020|2021

TAZZE

BICCHIERI

APRIBOTTIGLIA

PORTABOTTIGLIE

PORTA CALICE

GREMBIULI

CONTENITORE CIBO

TAGLIAPIZZA



**AR 4120
TAZZA**

Tazza bianca con trattamento per sublimazione, astuccio incluso. Capacità **325 ml.**

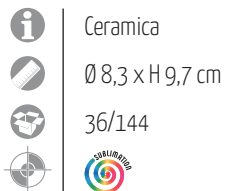
**AR 4121
TAZZA**

Tazza bianca con bordo e manico colorati. Astuccio incluso. Capacità **300 ml.**

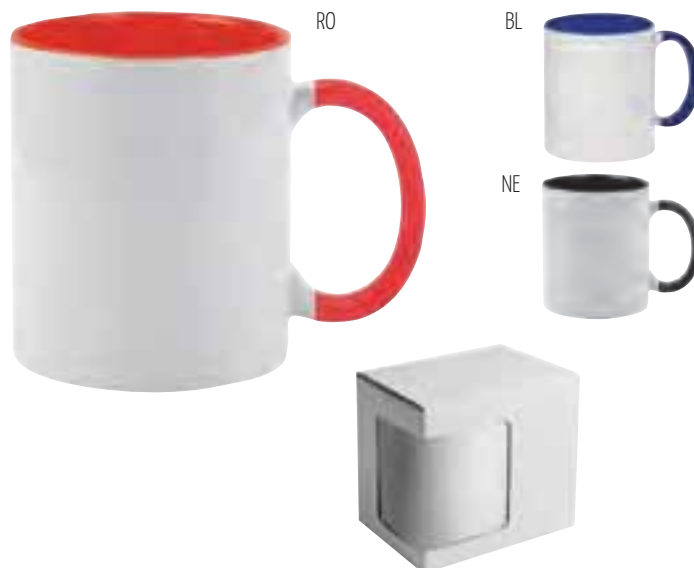
**AR 4127
TAZZA**

Tazza in fibra di bamboo, leggera, capacità **350 ml.**

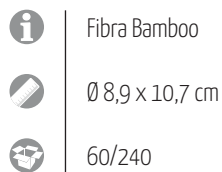
**AY 7745
BICCHIERE**

Bicchieri in plastica telescopico, custodia con moschettone, capacità **220 ml.**



AR 4130 CONTENITORE CIBO

Contenitore Cibo ermetico in PP con 3 scomparti (250 ml, 270 ml e 470 ml). Forchetta e coltello incluse. Adatto per microonde (rimuovere il coperchio).



Polipropilene



23,5 x 19,5 x 6 cm



5/60



AR 4131 BORSA TERMICA

Borsa Termica con Lunch box incorporato a due scomparti e coperchio in tinta, kit posate per una persona.



Poliestere 600D



17,0 x 25,0 x 7,5 cm



1/25



**AR 4075
APRIBOTTIGLIE**

Apribottiglie con funzione tappo in plastica e metallo.

-  Plastica e Metallo
-  9,5x4 cm
-  100/600



RO

BI



BL

NE

GI

**AR 4077
APRIBOTTIGLIE**

Apribottiglie in plastica e acciaio.

-  Plastica e Acciaio
-  10,2 x 3,5 x 0,4 cm
-  50/500



VE



BI

NE

RO

**AR 4070
APRIBOTTIGLIE**

Apribottiglie con Fidget Spinner integrato in plastica e metallo.

-  Plastica e Metallo
-  8,5x3,5x1,2 cm
-  50/500



RO

BL

NE

BI



AR 4086 TAGLIAPIZZA

Taglia pizza in acciaio inossidabile con server in acciaio inossidabile, robusta maniglia in plastica.



Acciaio e Plastica



28,7 x 11 x 1 cm



40/160



AR 4088 TAGLIAPIZZA

Tagliapizza con apribottiglia in plastica e metallo.



Plastica e Metallo



13x6 cm



50/200



**AR 4060
PORTABICCHIERE**

Portabicchiere da degustazione.



TNT



22 x 18 cm



50/200



BO



NE

**AR 4061
PORTABOTTIGLIE**

Borsa portabottiglia in tnt termosaldata, con soffietto alla base e manici fustellati.



TNT



17x40x10 cm



100/600



BO

VE



RO



NE

**AQ 4056
BORSA WINE**

Borsa porta 4 bottiglie in polipropilene.



Polipropilene



37x21x10,5 cm



10/100

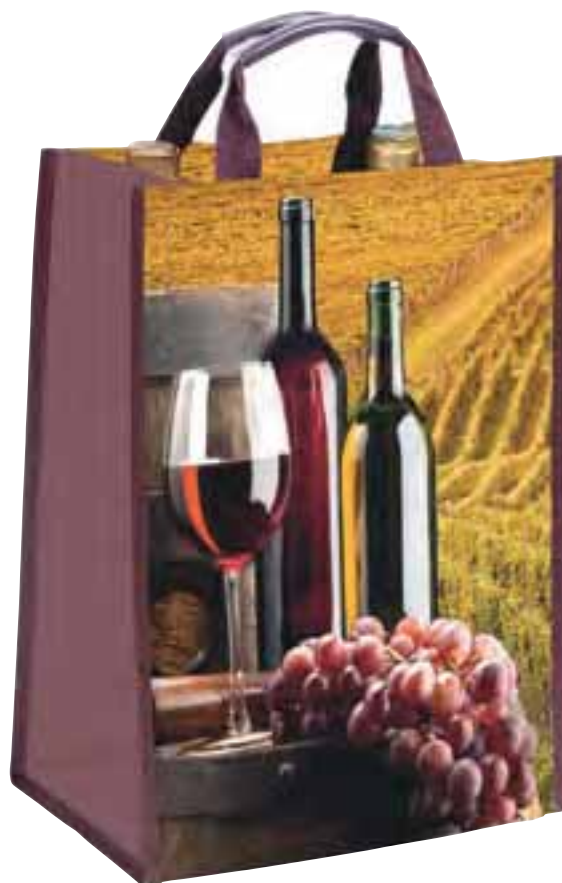

AR 4095 SET VINO

Set vino con 5 accessori in acciaio inossidabile, composti da termometro, anello salvagoccia, beccuccio versatore, tappo e cavatappi, confezione regalo (vino non incluso).



Cassetta in Legno
Accessori in Acciaio



36,4 x 11,3 x 11,3 cm



1/20



AR 4080 APRIBOTTIGLIE CAVATAPPI

Apribottiglie in metallo.



Metallo



12,5 x 2 cm



50/200





B0



B0





NE





NE

**AY 7340
GREMBIULE UOMO**

-  Cotone 65%, poliestere 35%
260 g/mq.
-  100x86 cm
-  10/50



**AY 7345
GREMBIULE DONNA**

-  Cotone 65%, poliestere 35%
260 g/mq.
-  57x70 cm
-  10/80





**AY 7347
GREMBIULE UOMO**

Con finto Gilet con 2 tasconi.



-  Gabardine in Policotone 65%, Poliestere 35% - 180 g/mq
-  100x86 cm
-  10/50

**AY 7350
GREMBIULE DONNA**

Con finto Gilet con 2 tasconi.

-  Gabardine in Policotone 65%, Poliestere 35% - 180 g/mq
-  68x87 cm
-  10/50

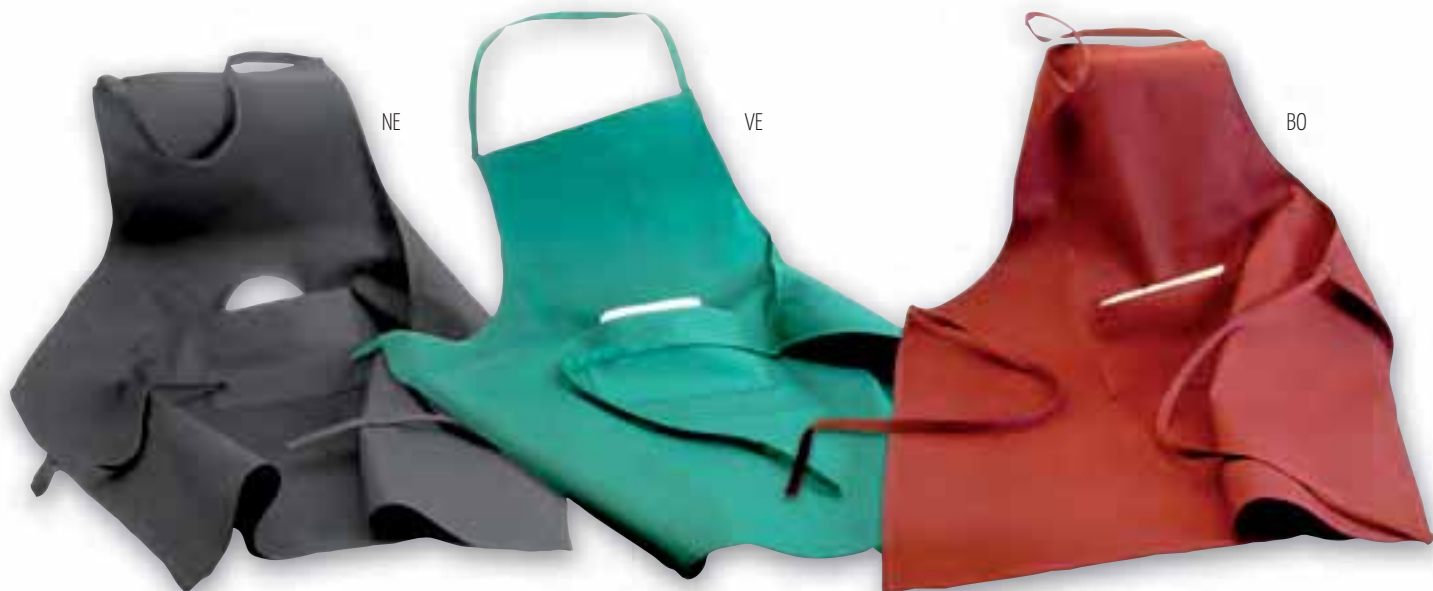

AY 7358 GREMBIULE CON TASCONE

-  Cotone pesante 100%
210 g/mq.
-  67x84 cm
-  10/80



AY 7365 GREMBIULE BIANCO CON TASCONE

Con tascone.

-  Cotone pesante 100% - 195 g/mq.
-  65x80 cm
-  10/100





BO



BL



VE





NE



MA

**AY 7360
GREMBIULE
BARMAN**

Con 3 tasche

-  Cotone 100% - 210 gr/mq
-  56x36 cm
-  10/50



AY 7359
GREMBIULE

Con tasca frontale cucita.



TNT



73x50 cm



10/50

promosolution2020|2021

**SPECCHIETTI
SPAZZOLE
SET MANICURE
LIMA PER UNGHIE
PINZETTA
VENTAGLIO
BEAUTY
PENNA ROSSETTO**



AS 5105 SPECCHIETTO



Specchietto da borsa in plastica.

-  Plastica/ Vetro
-  Ø 6 cm
-  72/720



AS 5110 SPECCHIETTO

Specchietto da borsa in plastica con ingrandimento.

-  Plastica/ Vetro
-  3,2x6,7 cm
-  100/500



AS 5102 SPECCHIETTO

Specchietto da borsa in alluminio , con secondo specchio d'ingrandimento. Confezionato in astuccio di cartoncino.



-  Alluminio/ Vetro
-  Ø 6,8X1,3 cm
-  50/300





**AS 5074
SPECCHIETTO
"MELA"**



Specchietto in PU. Confezione in astuccio.

-  Poliuretano/ Vetro
-  9x9,5 cm
-  50/200



**AS 5107
SPECCHIETTO**



Specchietto da borsa in plastica a forma di cuore, con secondo specchio d'ingrandimento.

-  Plastica/ Vetro
-  5,8X6,2X2,7cm
-  50/200



**AS 5095
SPAZZOLA**



Spazzola richiudibile con specchietto.

-  ABS/ Nylon/ PVC
-  10,7x4x2,8 cm
-  100/400



**AS 5096
SPAZZOLA**



Spazzola da viaggio richiudibile con specchio.

-  ABS/ Nylon/ PVC
-  Ø 6,6 X 2,9 cm
-  48/288



**AS 5115
MINILIME**

6 mini lime da unghie, nel design "dente di leone", contenute in confezione di cartoncino. Dim.

-  Catra/ EVA
-  5,5 x 6,2 x 0,4 cm
-  100/500



**AS 5116
LIME**



Lime per unghie in plastica.

-  Plastica
-  9x1 cm
-  50/250



**AS 5070
SET MANICURE**

Set che include forbici, lima per unghie, tagliaunghie e una cuticola implementare, dotato di astuccio con specchietto.

-  ABS/ Metallo/ Vetro
-  17x11 cm
-  25/100



AS 5064 PENNA A SFERA

Penna in plastica a forma di rossetto. Refil blu.



Plastica



9,8x1,8 cm



100/500



NE/RO



RS



RO

AS 5112 PINZETTA

Pinzetta In metallo, con astuccio cilindrico.



Metallo/ Plastica



Ø 1,1 x 11 cm



100/500



AY 7758 VENTAGLIO

Ventaglio in plastica.
Area di stampa: 6x1 cm



ABS



23x2,2x2 cm



50/250



BI



RO



**AS 5125
POCHETTE**

Pochette con chiusura a zip in nylon satinato.



Poliestere



17x12x5 cm



10/300



FX



GR

**AS 5120
POCHETTE**

Pochette con chiusura a zip in pvc satinato.



PVC



25x20,7x7,2 cm



50/150

BI



RO



AR



promosolution 2020|2021



**OMBvRELLI GOLF
OMBRELLI MANICO LEGNO
OMBRELLI PIEGHEVOLI**





**AT 5205
OMBRELLO**

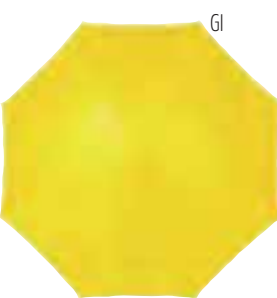
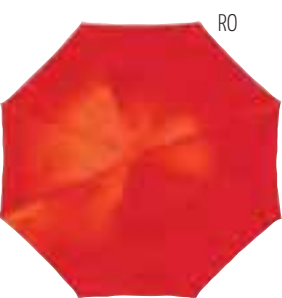

Ombrello con apertura automatica, struttura in metallo, manico in Eva, rivestimento in poliestere.

-  Poliestere
-  Ø 105 x H 84 cm
-  25



AT 5234
OMBRELLO
MAXI GOLF

Ombrello con custodia e tracolla in tinta. Stecca e raggi a doppio spessore in metallo. Manico in gomma morbida.

-  Poliestere 190T
-  Ø 125 cm
-  24



RO



AZ



VE



RY



**AT 5210
OMBRELLO**

Ombrello con apertura automatica,
struttura in alluminio, manico in Eva.
Rivestimento in nylon pongee.



Nylon Pongee



Ø 103 x H 82 cm



25



RY



BI





BL



NE

**AT 5232
OMBRELLO**

Ombrello Automatico con stecca in alluminio, raggi in fibra di vetro e punte in metallo, manico in alluminio-EVA, rivestimento e custodia in poliestere-pongee.

-  Poliestere
-  Ø 103 cm
-  36



VE



MA



BL



NE



**AT 5200
OMBRELLO
PIANTINO**

Ombrello automatico, 12 spicchi, con finiture in metallo laccato, manico gommato effetto soft touch.



Poliestere



Ø 102 x H 85 cm



48



NE



BI



GI



AR



RO



BL



MA



BO



FX

**AT 5198
OMBRELLO**

Ombrello a scatto automatico in poliestere. Manico curvo e puntale in legno.



Poliestere



Ø 102 x H 89 cm



36



AR



RO



BL



BI



NE

**AT 5226
MINI OMBRELLO**

Mini ombrello con apertura manuale, struttura in metallo, manico in plastica argentata, rivestimento e custodia in poliestere.



Poliestere



Ø 98 cm x H 55 cm



40



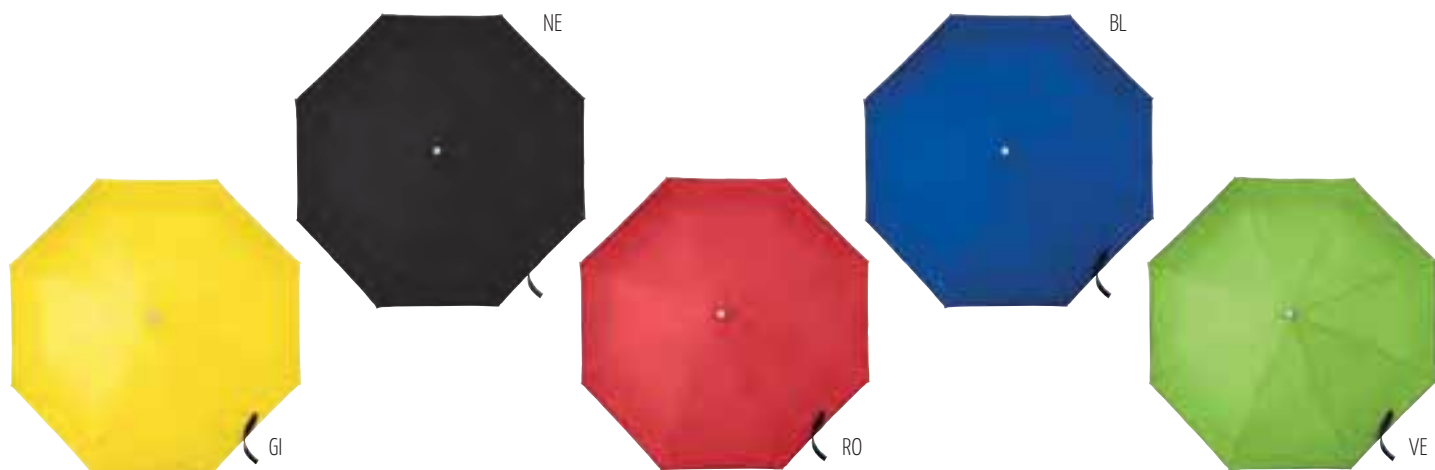

AZ



**AT 5220
OMBRELLO**



Ombrello pieghevole automatico "Apri & Chiudi" in pongee seta, antivento, otto pannelli, chiusura in velcro, fodera a tema colore, cordino comodo per il trasporto.

-  Poliestere
-  97,0 x 54,0 cm
-  36



AT 5256
OMBRELLO PIEGHEVOLE
CON PORTA OMBRELLO

Un set composto da un mini ombrello 3 sezioni con copertura bicolore e manico gommato al quale è abbinato un simpatico e comodissimo porta ombrello da tavolo. Il tutto confezionato in box regalo LAVILLE.

-  Poliestere
-  Ø 98 cm
-  24

promosolution2020|2021

**PORTACARD
PORTALOTTO
PORTARICETTE
PORTABIGLIETTO AEREO
PORTANOME VALIGE**



**AU 5950
PORTACARD
12 POSTI**

Portacard in PU con 6 bustine interne. Chiusura con bottoncino.



Poliuretano



11x8x1,5 cm



100/300



**AU 5952
PORTACARD RFID**

Portacard esterno in similpelle, slot interna in alluminio con protezione delle card da lettori RFID, pulsante espelli carte.



Poliuretano/ Alluminio



7x10x2 cm



40/200



AU 5960 PORTACARD RFID

Portacard slot in alluminio con protezione delle card da lettori RFID, pulsante espelli carte.



Alluminio



6,3x9,5x0,9 cm



50/200

AZ



GR



RO



NE



AU 5965 PORTACARD RFID

Portacard slot in plastica con protezione delle card da lettori RFID, pulsante espelli carte.



Plastica



6,1x10x1 cm



50/500

RO



BL





NE



**AU 6000
PORTACARD**



Portacard Singolo realizzato in tam.

-  TAM
-  9x6 cm
-  100/300



**AU 6010
PORTACARD**

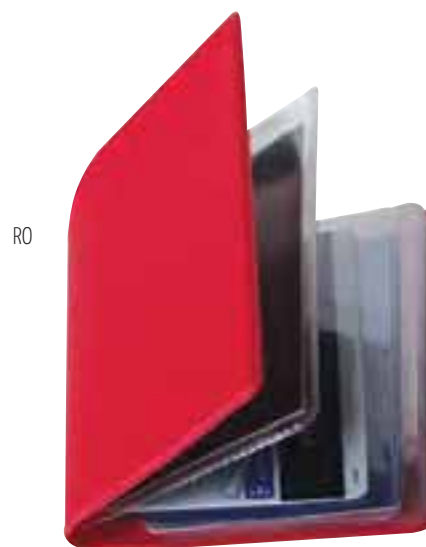
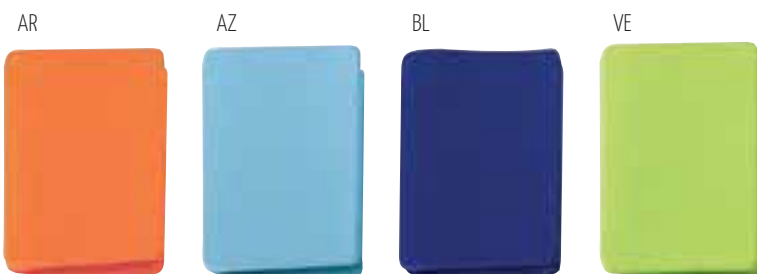

Portacard 4 ante realizzato in tam, contiene 10 card.

-  TAM
-  10x7,5 cm
-  100/300



**AU 6005
PORTACARD**

Portacard 2 ante realizzato in tam.

-  TAM
-  9 x 6 cm
-  100/300

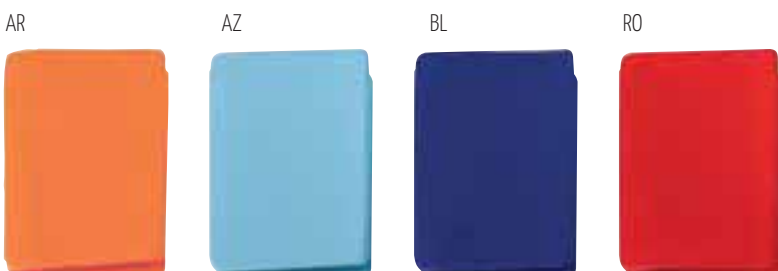

AU 5970 PORTACARD RFID

Portacard progettato per proteggere la tua carta di credito dalle scansioni di dati bancari dei lettori RFID. Composizione: PE con foglio alluminio interno.



PE + Alluminio



9x6,1 cm



100/200



RO



BL



BI



NE



SI

AU 6034 PORTACARD PORTABIGLIETTI

Portacarte di credito e Portabiglietti in plastica morbida.



PVC



9 x 6 cm



100/500



BL

TR

RO

GI

VE



AU 6038 PORTACARD

Portacard singolo realizzato in PVC elite.



PVC



9,2x6 cm



100/500



SI

BL

BI

RO

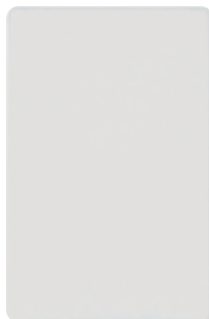

AU 6033 PORTACARD

Portacard 4 bustine, può contenere 10 card, realizzato in pvc elite.



PVC



9,4 x 6,7 cm



100/500



SI

BL

BI

RO

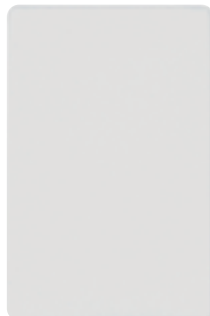

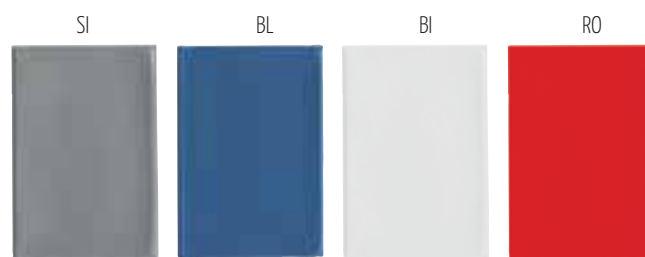
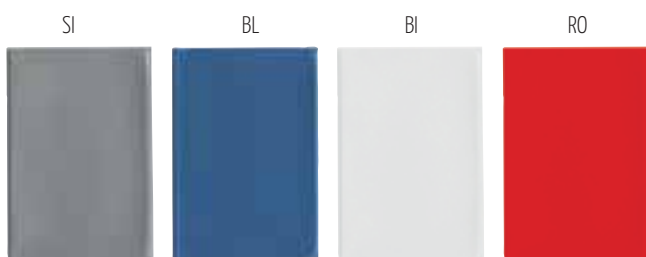

**AU 6041
PORTACARD**

Portacard 2 ante realizzato in pvc elite.



PVC



9,2 x 6 cm (chiuso)



100/500

**AU 6039
PORTACARD**

Portacard 3 tasche realizzato in pvc elite.



PVC



9,2x6 cm (chiuso)



100/500

AU 6030 PORTALOTTO

Portalotto 2 ante in PVC.



PVC



22,5 x 12 cm (chiuso)



100/300

BI

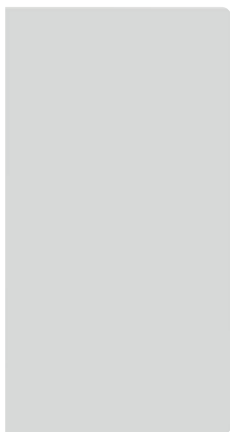

BL



RO



AU 6027 PORTALOTTO

Portalotto in pvc con pattina di chiusura.



PVC



23x12,5 (chiuso)



100/300

RO



BI



BL



AU 6020
PORTAOGGETTI
PORTAMASCHERINA

Bustina portaoggetti/
 portamascherina in pvc.



PVC
 12 x 12 cm
 (chiuso)
 100/500



TERMOALDATI

AU 6052
PORTARICETTE
PORTATESSERE
PORTASCONTRINI

2 ante realizzato in alfa.



PVC
 17x12 cm
 100/300

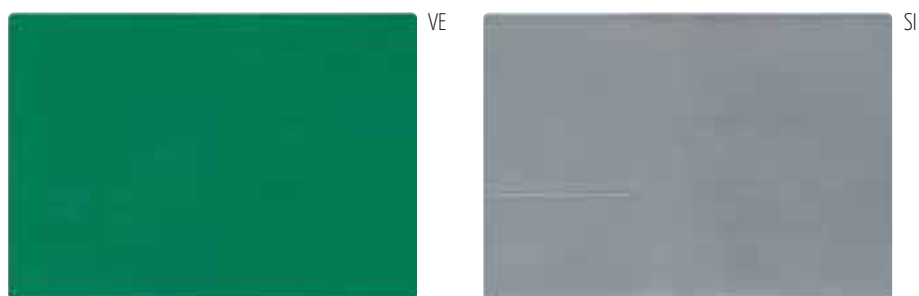

**AU 6035
PORTA NOME**

Per bagaglio in DEVON.



DEVLON



10 x 6 cm



100/500



BL



BI



RO



VE



**AU 6027
PORTABIGLIETTO
AEREO**

In pvc con pattina di chiusura.



PVC



23x12,5 (chiuso)



100/300

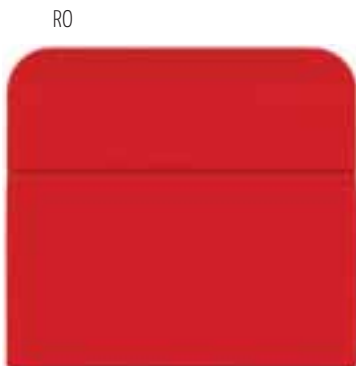

RO

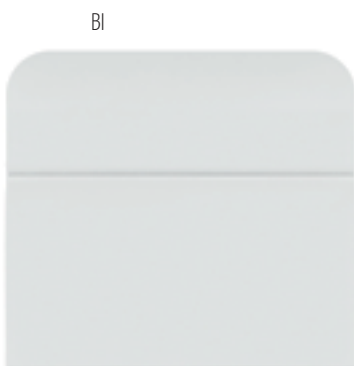

BI



BL

promosolution 2020|2021

**PORTADOCUMENTI
PORTASSICURAZIONI
PORTATARGA
PORTAPOLIZZA
DISCO ORARIO**



**AV 6239
PORTADOCUMENTI**

Portadocumenti con fascetta in tam bicolore con bottone.



TAM



19,5 x14 cm



100



BL



GR



RO



**AV 6241
PORTADOCUMENTI**

Portadocumenti in tam bicolore con bottone.



TAM



19x13 cm



50/200



VM



AZ



VE



BL



AR



RO



AV 6240 PORTADOCUMENTI

Portadocumenti con fascetta in tam
bicolore.



TAM



19x13 cm



50/200



GI



AZ



AR



VM



RO



VE

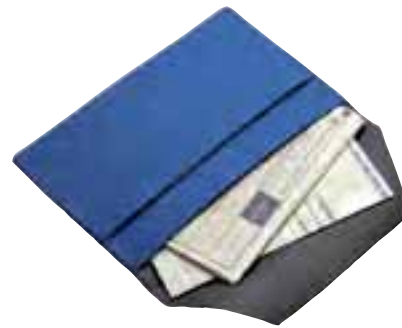

BL



AV 6243 PORTADOCUMENTI MOTO

Portadocumenti con pattina realizzato in
tam.



TAM



16,5x13 cm



50/300



RO



VM



AR



AZ



BL



**AV 6205
PORTADOCUMENTI**

Portadocumenti in Tam, con cuciture colorate.



TAM



18,5x13 cm



100

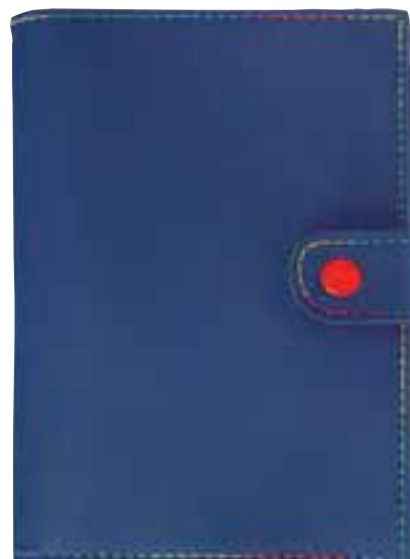

**AV 6210
PORTADOCUMENTI**

Portadocumenti in Tam, con cuciture colorate.



TAM



20x14 cm



100

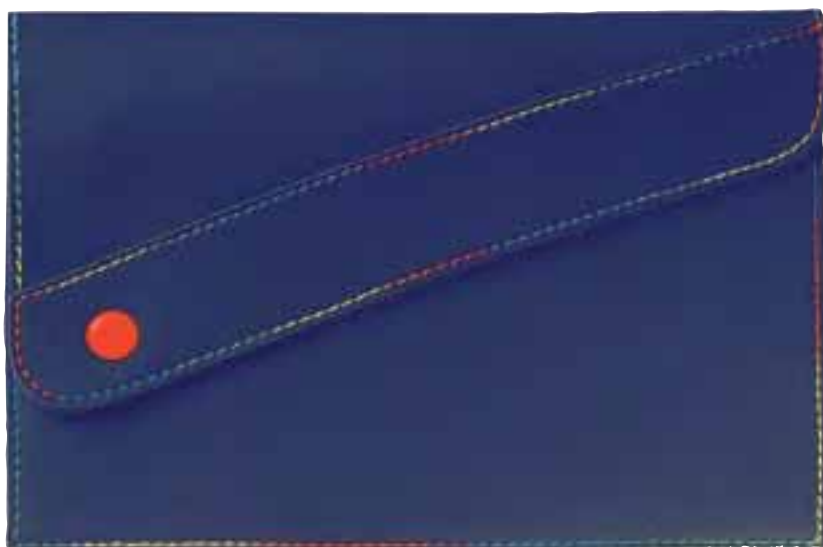

AV 6242 PORTADOCUMENTI

Portadocumenti Realizzato in TAM con tasca trasparente.



TAM



18x13 cm



50/500

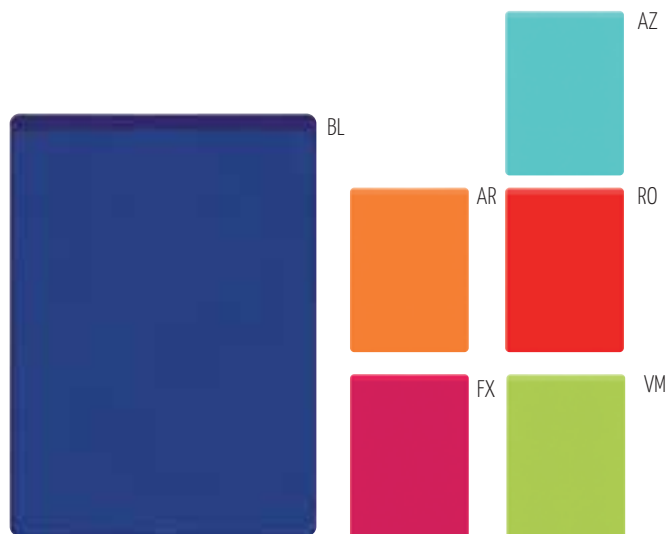

AU 6042 PORTADOCUMENTI MOTO

Portadocumenti realizzato in PVC con tasca trasparente.



PVC



18x13 cm



100/500



AV 6250 DISCO ORARIO

Disco orario in PVC. Dim.



PVC



15X11,7 cm



50/500



AU 6055 PORTAPOLIZZA

Porta polizza in PVC con tasca trasparente.



PVC



21x30 cm





100/500



**AV 6280
PORTATARGA
POSTERIORE AUTO**



Portatarga in metallo verniciato grigio.

-  Metallo
-  53,5x13,5 cm
-  100



**AV 6285
PORTATARGA
ANTERIORE AUTO**



Portatarga in metallo verniciato grigio.

-  Metallo
-  37,5x13,5 cm
-  100



**AV 6260
PORTATARGA
POSTERIORE AUTO**



Portatarga in metallo alluminio grigio.

-  Alluminio
-  53,5x13,5 cm
-  100



**AV 6265
PORTATARGA
ANTERIORE AUTO**



Portatarghe in metallo alluminio grigio.

-  Alluminio
-  37,5x13,5 cm
-  100



AV 6270
PORTATARGA
POSTERIORE AUTO



Portatarga in metallo verniciato nero.

-  Metallo
-  53,5x13,5 cm
-  100



AV 6275
PORTATARGA
ANTERIORE AUTO



Portatarga in metallo verniciato nero.

-  Metallo
-  37,5x13,5 cm
-  100



AV 6290
PORTATARGA
POSTERIORE AUTO



Portatarga in polipropilene nero.

-  Polipropilene
-  52,5x13 cm
-  50



AV 6295
PORTATARGA
POSTERIORE AUTO

Portatarghe in polipropilene argentato.

-  Polipropilene
-  52,5x13 cm
-  50



**AV 6315
PORTATARGA
PER MOTO**

Portatarga In metallo Grigio.



Metallo



19,5x23 cm



50



**AV 6320
PORTATARGA
PER MOTO**

Portatarga In Metallo Nero.



Metallo



19,5x23 cm



50



**AV 6339
PORTATARGA
PER MOTO**

Portatarga in ABS.



ABS



18,5 x 20 cm



100



promosolution 2020|2021

**FLESSOMETRI
DOPPIO METRO
MATITA FALEGNAME
TAGLIERINI
ARTICOLI FARMACEUTICI
TORCE
CALZASCARPE**



AW 6550 FLESSOMETRO

Flessometro da 5 mt, con blocco del nastro, riavvolgimento automatico impugnatura in gomma.

 Plastica e Metallo

 7,4x6,9x2,8 cm

 20/80



AW 6540 FLESSOMETRO

Flessometro da 3 mt, con blocco del nastro, riavvolgimento automatico impugnatura in gomma.

 Plastica e Metallo

 6,4x6,1x3,8 cm

 20/120



AW 6565 ROTELLA METRICA

Rotella metrica 20 mt. in plastica gialla e nera



 Plastica

 L. 20 mt

 10/30



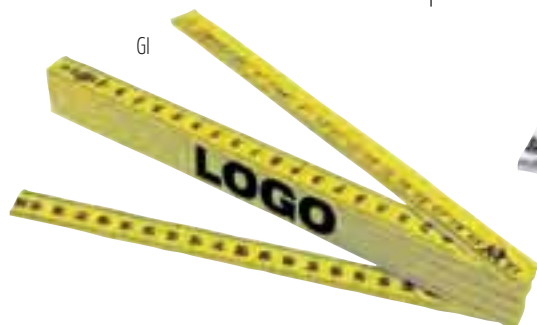

**AW 6515
DOPPIO METRO
IN ABS**

-  ABS
-  L. 2 mt
-  20/200



**AW 6520
MATITA FALEGNAME**

-  Legno
-  17x1 cm
-  100/1000





**AW 6525
DOPPIO METRO
IN LEGNO**

-  Legno
-  2 mt
-  12/120



**AW 6576
TORCIA LED**

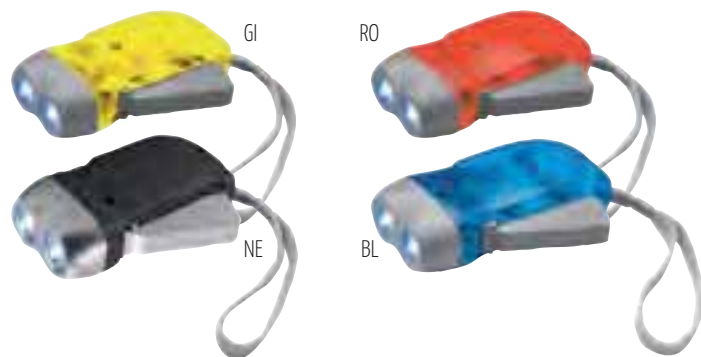

Torcia con 2 luci led, senza batteria con caricamento a dinamo.

-  Plastica e Metallo
-  10x5x2,5 cm
-  20/200



**AW 6570
COLTELLINO
3 FUNZIONI**



Coltellino tre funzioni in plastica e acciaio inox.

-  ABS/ Acciaio
-  6,2x2,2x1,0 cm
-  20/200



**AW 6572
COLTELLINO
MULTIFUZIONE**

Coltellino 7 funzioni, in acciaio inox.

-  Acciaio
-  9,4x2,8x1,5 cm
-  20/160



AW 6529 CUTTER

Cutter rettangolare in plastica.

-  Plastica
-  10,2x3x1 cm
-  60/180

RO





BL



AW 6526 CUTTER

Cutter in plastica trasparente.

-  Plastica
-  12,6x2,5x1 cm
-  60/180

AR



GI





AZ



AW 6524 CUTTER

Cutter in acciaio inox

-  Acciaio
-  12,8x1,1x0,9 cm
-  100/500



**AW 6584
PORTAPILLOLE**

Portapillole in plastica trasparente a 3 scomparti.

-  Plastica
-  6x3,5 cm
-  100/500



**AW 6583
PORTAPILLOLE**

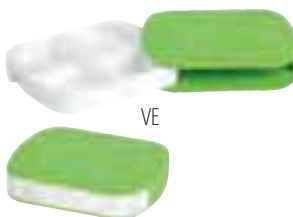
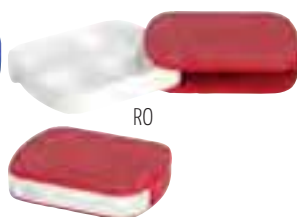
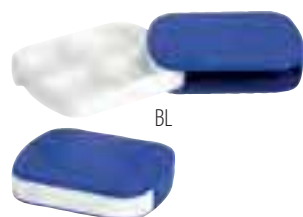

Portapillole in plastica 4 scomparti.

-  Plastica
-  7,9x6,3x1,6 cm
-  50/250



**AW 6587
PORTAPILLOLE**

Portapillole in plastica bianca a 3 scomparti.

-  Plastica
-  6,5x3,5x1,5 cm
-  100/500



**AW 6586
TAGLIA PILLOLE**

Taglia pillole "Easy Cut" in plastica bianca, dotato, all'interno, di un piccolo coltello che divide la pillola richiudendo la scatola.

-  Plastica
-  Ø 7 cm
-  50/300



AW 6589 DIFFUSORE SPRAY

Disinfettante spray tascabile.



Plastica



1,6x 14 cm



50/250

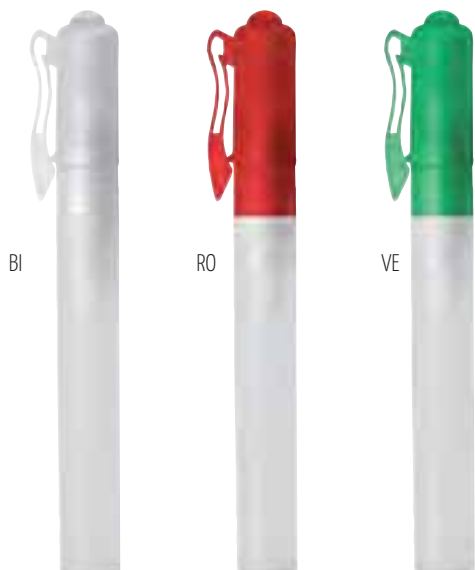

AW 6590 GEL DISINFETTANTE MANI

Gel in formato tascabile, in PET,
capacità 15 ml.



PET



6,3x3,2x1,9 cm



50/250



AW 6591 SPAZZOLINO

Spazzolino da viaggio.



Plastica



10,3x 2,4x1,5 cm



125/600



AW 6595 LEVA FUSTELLE

Levafustelle in plastica e acciaio.
Confezione in polybag.



Plastica



13 cm



100/500



AW 6599 PORTA ABITI

Porta abiti da viaggio in PEVA, con cerniera, finestra trasparente e apertura per gruccia.



PEVA



100x60 cm



10/120



AW 6600 CALZASCARPE

Calzascarpe con foro per appenderlo e ampio spazio per la stampa. Dim.



Plastica



18,9 x 4,2 x 1 cm



100/600

NE



RO



BL



promosolution2020|2021

**ZAINI PORTA PC
ZAINI TEMPO LIBERO
ZAINI CAMOUFLAGE
BORSONI SPORT
BORSA TERMICA**





Luxury gift box

Functional pockets

YKK zippers

Hangtags

Adjustable buckle

Name card pocket



AF 1655 ZAINO PORTACOMPUTER

Zaino in poliestere con due scomparti con chiusura a doppia zip, scomparto con interno imbottito per tablet e computer portatile 15", scomparto secondario con varie tasche interne, tre tasche esterne frontali con cerniera piu' due tasche laterali, due spallacci imbottiti e regolabili, in elegante scatola regalo.



Poliestere



35 x 45 x 18 cm



1/1





BL

GR



AF 1656 ZAINO ANTIFURTOv



Zaino in nylon con due scomparti con chiusura a doppia zip, scomparto con interno imbottito per tablet e computer portatile 15", connettore USB, varie tasche interne, tasca segreta con zip sul retro, due spallacci imbottiti e regolabili.

	Nylon
	33 x 44 x 12 cm
	1/10



AF 1659 ZAINO ANTIFURTO

bicolore semirigido, parte centrale in nylon e parte superiore e inferiore in PVC, ampio scomparto interno, tasca porta computer da 15 pollici, varie tasche interne, porta USB esterna con cavo all'interno, tasca segreta con cerniera sul retro, bretelle imbottite regolabili.

	Nylon + PVC
	45x35x11 cm
	1/10



AF 1665 ZAINO PORTACOMPUTER

Zaino portacomputer 15 pollici, scomparto principale con vano imbottito per un portatile, tasche interne, vano sulla parte anteriore con chiusura lampo, manico, spallacci regolabili.



Poliestere 600D e PVC



44,0 x 28,5 x 12,0 cm



1/10



AF 1663 ZAINO BUSINESS

con vano principale, vano imbottito per computer portatile e tablet da 15", connettore usb, tasca con cerniera sul davanti e tasca segreta con cerniera sul retro. Materiale nylon.



Nylon



31x44x13 cm





1/10



AF 1669 ZAINO PORTACOMPUTER

Zaino in nylon con due scomparti, scomparto principale con interno imbottito per computer portatile, scomparto secondario con varie tasche interne, due tasche esterne frontali con cerniera e due tasche a rete sui lati, due spallacci imbottiti, manico con impugnatura ergonomica.

	Nylon
	30x45x15 cm
	1/10



BL



NE

AZ 7025 ZAINO

scomparto frontale a cerniera dotato di gancio a moschettone, scomparto principale a cerniera con tasca e all'interno tasca piccola a cerniera come pure uscita per gli auricolari, 2 scomparti a reti sui lati e lacci comprimanti, manico rinforzato, spalline e schienale con comoda imbottitura.



Poliestere 1680D



48 x 32 x 18 cm



1/15



GR



NE

**AZ 7026
ZAINO**

In poliestere, ampio scomparto con tasca porta computer 15", chiusura a cerniera doppio cursore, spalline regolabili.



Poliestere



45x30x13 cm



1/30



RO



**AZ 7032
ZAINO**

Con tasca anteriore a cerniera, scomparto principale, spalline imbottite regolabili e schienale imbottito.



Poliestere 600D



33x41x19 cm



10/50



VM



**AZ 7033
ZAINO**

Con tasca anteriore a cerniera, scomparto principale, spalline imbottite regolabili e schienale imbottito.



In poliestere 600D



30x39,5x10



10/50

RO



**AZ 7028
ZAINO**

Con scomparto frontale a cerniera con uscita per auricolari, una tasca esterna a cerniera, maniglia, 2 scomparti esterni a rete sui lati, spalline imbottite.



Poliestere 600D



40x28,5x17 cm



10/50



NE



GI



AR



VM



RO



BL



BI



**AZ 7023
ZAINO**

Zaino leggero e compatto con spallacci regolabili, tasca frontale con cerniera verticale.



Poliestere 600D - 145 gr/mq



23x40x12 cm



10/50





AZ



AZ 7019
ZAINETTO POLIESTERE

Con doppio cordoncino di chiusura, angoli rinforzati, poliestere 210 D.

-  Poliestere 210D
-  42x33 cm
-  10/100



AZ 7018 ZAINETTO POLIESTERE

Con doppio cordoncino di chiusura, tasca esterna con zip e uscita per auricolari, angoli rinforzati.

 Poliestere 210D

 45x35 cm

 10/50

BI



GI



AR



RO



FX



VE



RY



NE



**AZ 7031
ZAINETTO TNT**

Con doppio cordoncino di chiusura in tessuto non tessuto.



TNT - 80gr/mq



42x36 cm



20/100

AZ 7015
ZAINO
CAMOUFLAGE

In poliestere 210D con angoli rinforzati.



Poliestere 210D



44x34 cm



10/50



AZ 7016
ZAINO
CAMOUFLAGE

Richiudibile in poliestere 190T.



Poliestere 190D



43x29X11 cm



10/50





AZ 7113 BORSONE SPORTIVO

Bicolore, ampio vano centrale, tasche laterali e tasca anteriore, doppio manico, tracolla regolabile, confezione in polybag.

 Poliestere 600D

 55x33x28 cm

 1/20



AZ

GR



BL



VE



FX



AR



RO



AZ 7115 BORSA SPORTIVA

Borsa in poliestere 600D, con tracolla regolabile, scomparto principale più tasca laterale con cerniere, manici e fondo rinforzati. Dim. 48x28x22 cm



Poliestere 600D



48 x 28 x 22 cm



1/20



RO



NE



BL



AZ 7116 BORSONE SPORTIVO

Con ampio scomparto centrale chiusura zip doppio cursore, tasca esterna con zip, vano laterale porta scarpe, doppio manico e tracolla regolabile.



Poliestere 600D



56x30x28 cm



1/30



RETRO



RO





NE



RY

AZ 7118
BORSA SPORTIVA

Borsa sportiva/viaggio, vari scomparti con chiusura lampo, vano extra per le scarpe, tracolla regolabile.

-  Poliestere 600D
-  49,0 x 29,0 x 24,0 cm
-  1/30



BL



GR



AZ 7120 BORSA SPORTIVA

Borsa sportiva 2 IN 1: ampio scomparto principale con cerniera, tasca frontale con cerniera, 1 tracolla aggiuntiva, 2 tasche laterali con cerniera, maniglie rinforzate per il trasporto, utilizzabile anche come zaino.



Poliestere 300D/600D



55 x 30 x 28 cm



1/20

BL



NE



AZ 7125 BORSA SPORTIVA

Borsa sportiva con grande scomparto separato per scarpe, scomparto principale e 2 tasche laterali con cerniera, tasca sul retro, fondo resistente all'acqua, tracolla regolabile e asportabile fornita di parte imbottita.



Poliestere 600D



60 x 36 x 26 cm



1/15

AZ



BL



RO



VE



GI



AZ 7077
BORSA TERMICA

Borsa con scomparto principale isolante a cerniera, tasca laterale e tracolla regolabile.



Poliestere 420D



23x16x26 cm



1/25

promosolution 2020|2021

**BORRACCE
BICCHIERI
BORSA MARE
VENTAGLIO
OCCHIALI DA SOLE
COPERTA IN PILE
STUOIA
GIOCHI MARE
BRACCIALETTI**



**AY 7730
BORRACCIA**

Borraccia waterproof con moschettone, in alluminio, capacità **400 ml.**



Alluminio



Ø 6,6 x 17,5 cm



48



**AY 7731
BORRACCIA**

Borraccia waterproof con moschettone, in alluminio, capacità **750 ml.**



Alluminio



Ø 7,3 x 25,0 cm



60



AY 7732 BORRACCIA

Borraccia botton push, beccuccio pieghevole, in acciaio inossidabile, tappo in plastica a tema colore, capacità **600 ml**.



Acciaio inossidabile



Ø 7,5 x 23 cm



35



AY 7736 BORRACCIA

Borraccia in acciaio inossidabile a doppia parete, tappo a vite, capacità **500 ml**.



Acciaio inossidabile



Ø 6,8 x 25,7 cm



40



**AY 7742
BORRACCIA**

Borraccia in AS colorata trasparente, base e tappo a vite in acciaio inox, capacità **650 ml.**



AS trasparente



Ø 7,5 x 23,5 cm



25



RO



RY



TR



VM



**AY 7743
BORRACCIA**

Borraccia in vetro con tappo a vite e passamano, ricoperta da guaina protettiva colorata estraibile, capacità **450 ml.**



Vetro



Ø 6,5 x 18,5 cm



40



**AR 4120
TAZZA**

Tazza bianca con trattamento per sublimazione, astuccio incluso. Capacità **325 ml.**



Ceramica
Ø 8,3 x H 9,7 cm
36/144



**AR 4121
TAZZA**

Tazza bianca con bordo e manico colorati. Astuccio incluso. Capacità **300 ml.**



Ceramica
Ø 8,2x9,5 cm
36/144

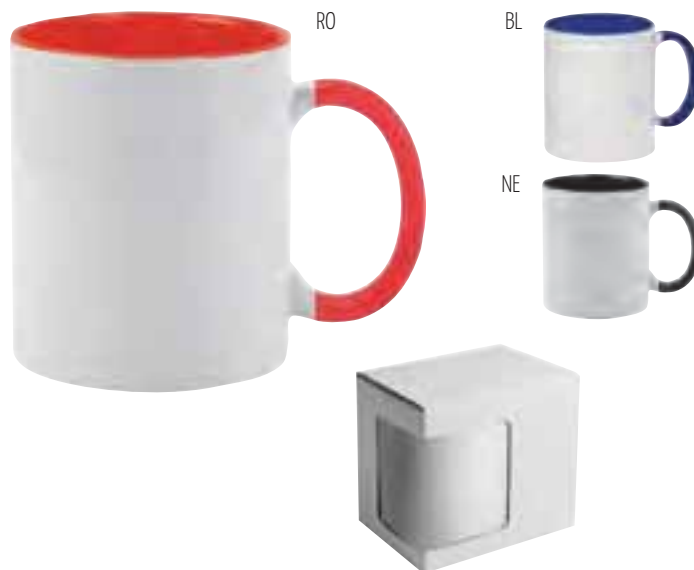

**AR 4127
TAZZA**

Tazza in fibra di bamboo, leggera, capacità **350 ml.**



Fibra Bamboo
Ø 8,9 x 10,7 cm
60/240



**AY 7745
BICCHIERE**

Bicchieri in plastica telescopico, custodia con moschettone, capacità **220 ml.**



Plastica
6,8 x 8,5 cm
50/125





**AY 7753
BORSA CAPRI**

Multiuso richiudibile a strappo, manici in elegante corda di cotone con fori in metallo, ideale per spiaggia, spesa e il tempo libero.

-  Poliestere 300D
-  45x35x18 cm
-  1/30

AY 7757 COPERTA

Coperta in pile, con maniglia in nylon.



Pile - 180 gr/mq



160x125 cm



1/20



TEMPO LIBERO



AY 7756 STUOIA

Stuoia da spiaggia pratica da arrotolare con cerniera e tracolla e poggiatesta.



PVC - TNT



180x60 cm



1/50

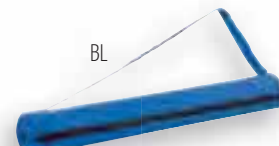

**AY 7751
OCCHIALI DA SOLE**

Modello classico, con protezione UV 400



PVC/ Policarbonato



14x4,5 cm



50/250



**AY 7758
VENTAGLIO**

Ventaglio in plastica.
Area di stampa: 6x1 cm



Plastica



23x2,2x2 cm



50/250



AY 7765 PALLONE

Pallone da mare bicolore con spicchi alternati colorati.



PVC



Ø 26 cm



50/300

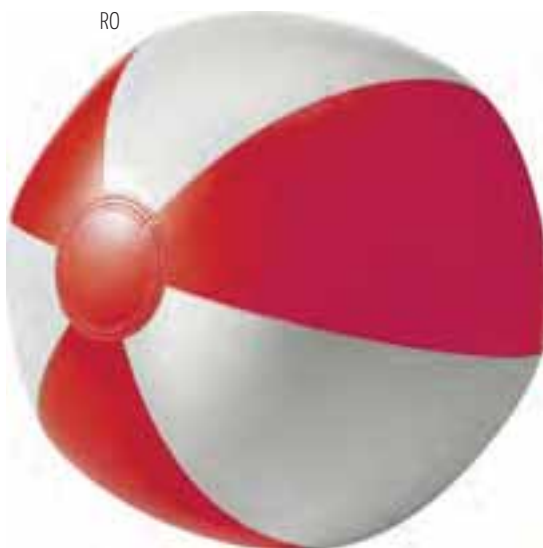

NE

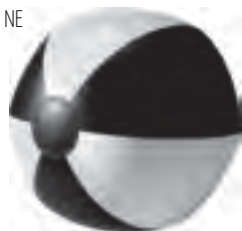

VE



BL

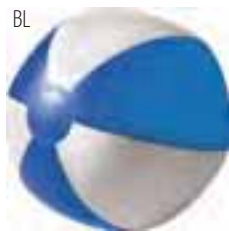

GI



AR



AY 7766 PORTACELLULARE

Custodia protettiva impermeabile in PVC, resistente all'acqua per dispositivi mobile, cordino con chiusura di sicurezza lungo circa 46 cm. Grazie allo speciale materiale della custodia è possibile azionare direttamente lo schermo del proprio mobile.



PVC



26 x 11,1 x 0,1 cm



100/500

NE



RO



RY



BI





VM





**AM 2565
POSACENERE
TASCABILE**

In PVC, Richiudibile con bottone.

-  PVC
-  8 x 8 cm
-  50/250

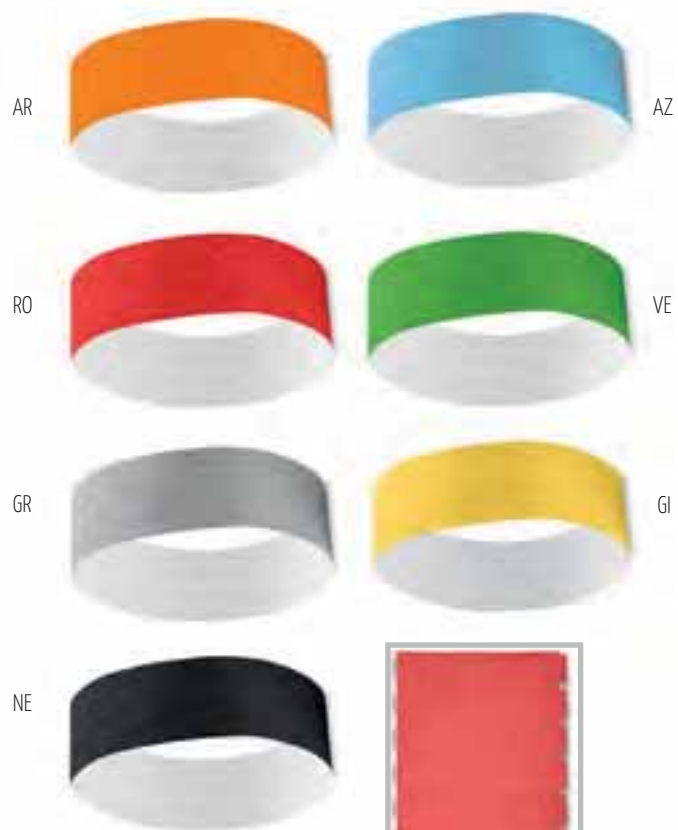

Fornito a strisce da 10 pz.



**AN 2896
BRACCIALETTA**

Bracciale in Tyvek con chiusura adesiva.

-  Tyvek
-  24,5 x 1,9 cm
Area di stampa: 6x1 cm
-  100/500

promosolution 2020|2021

T-SHIRT

POLO

FELPE

PILE

GIUBBINI

GILET

WORK

CAPPELLI





PAYPER
CALIFORNIA

SURF CLUB
PAYPER
LIVE YOUR DREAM. DRESS PAYPER.

SURF CLUB
PAYPER
LIVE YOUR DREAM. DRESS PAYPER.



T-SHIRT



AY 7443 SUNSET

T-Shirt girocollo, manica corta, colletto in costina misto spandex da 1,5 cm con cucitura ribattuta, nastro di rinforzo da spalla a spalla, struttura tubolare. Priva di busta per confezionamento.



Cotone - 150 g/mq
XS - S - M - L - XL - XXL - 3XL
(colori Blu, Melange, Nero, Smoke e Arancio anche 4XL - 5XL)



5/100

AY 7443-BI SUNSET WHITE

T-Shirt girocollo, manica corta, colletto in costina misto spandex da 1,5 cm con cucitura ribattuta, nastro di rinforzo da spalla a spalla, struttura tubolare. Priva di busta per confezionamento.



Cotone - 150 g/mq



XS - S - M - L - XL - XXL
3XL - 4XL - 5XL



5/100



SURF CLUB
PAYPER
LIVE YOUR DREAM. DRESS PAYPER.

JG



VA



BI



T-SHIRT

NE



RS



ML



WB



BO



RO



AR



GI



LL



FX



VE



BL



RY



BA



AY 7446 SUNSET LADY

T-Shirt girocollo, manica corta, colletto in costina misto spandex da 1,5 cm con cucitura ribattuta, nastro di rinforzo da spalla a spalla, taglio sfiancato. Priva di busta per confezionamento.



Cotone - 150 g/mq



XS - S - M - L - XL
(Nero disp. XXL)



5/100

AY 7446-BI SUNSET LADY WHITE

T-Shirt girocollo, manica corta, colletto in costina misto spandex da 1,5 cm con cucitura ribattuta, nastro di rinforzo da spalla a spalla, taglio sfiancato. Priva di busta per confezionamento.



Cotone - 150 g/mq



XS - S - M - L - XL - XXL



5/100



AY 7450 PRINT

T-Shirt girocollo, manica corta, colletto in costina misto spandex da 1,5 cm con cucitura ribattuta, nastro di rinforzo da spalla a spalla, struttura tubolare. Busta per confezionamento non inclusa.



Cotone Jersey - 150 g/mq



XS - S - M - L - XL - XXL - 3XL
(Blu, Royal e Nero disponibile
4XL - 5XL)



10/100

AY 7450-BI PRINT WHITE

T-Shirt girocollo, manica corta, colletto in costina misto spandex da 1,5 cm con cucitura ribattuta, nastro di rinforzo da spalla a spalla, struttura tubolare. Busta per confezionamento non inclusa.



Cotone Jersey - 150 g/mq



XS - S - M - L - XL - XXL
3XL - 4XL - 5XL



10/100

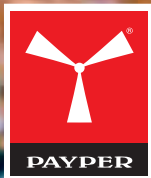

BI

T-SHIRT



AY 7485 SUNSET KIDS

T-shirt bambino cotone jersey pettinato girocollo manica corta, colletto in costina con cucitura ribattuta sul davanti, nastro di rinforzo da spalla a spalla. Priva di busta per confezionamento.



Cotone - 150 g/mq
S(5/6) - M (7/8) - L(9/10)
XL(11/12) XXL(13/14)



5/100

AY 7485-BI SUNSET KIDS WHITE

T-shirt bambino cotone jersey pettinato girocollo manica corta, colletto in costina con cucitura ribattuta sul davanti, nastro di rinforzo da spalla a spalla. Priva di busta per confezionamento.



Cotone Jersey - 150 g/mq
XXS(1/2 ANNI) - XS (3/4 ANNI)
S(5/6) - M (7/8) - L(9/10)
XL(11/12) XXL(13/14)



5/100

BL



RO



RY



AR



TU



GI



VE



FX



NE



ML



BI



AY 7460 T-SHIRT UOMO

T-shirt girocollo manica corta, colletto in costina misto spandex da 1,5 cm con cucitura ribattuta sul davanti, maniche corte e strette, struttura tubolare.



Cotone - 150 g/mq



S - M - L - XL - XXL - 3XL



10/100

AY 7460-BI T-SHIRT UOMO WHITE

T-shirt girocollo manica corta, colletto in costina misto spandex da 1,5 cm con cucitura ribattuta sul davanti, maniche corte e strette, struttura tubolare. In Jersey 100% cotone.



Cotone Jersey - 150 g/mq



S - M - L - XL - XXL - 3XL



10/100



BI



AY 7462 KIDS

T-shirt girocollo manica corta, colletto in costina misto spandex da 1.5 cm con cucitura ribattuta sul davanti, maniche corte e strette, struttura con cuciture laterali.



Cotone - 150 g/mq
XXS(1/2 ANNI) - XS (3/4 ANNI)
S(5/6) - M (7/8) - L(9/10)
XL(11/12) XXL(13/14)



10/100

AY 7462-BI KIDS WHITE

T-shirt girocollo manica corta, colletto in costina misto spandex da 1.5 cm con cucitura ribattuta sul davanti, maniche corte e strette, struttura con cuciture laterali. In Jersey 100% cotone.



Cotone Jersey - 150 g/mq
XXS(1/2 ANNI) - XS (3/4 ANNI)
S(5/6) - M (7/8) - L(9/10)
XL(11/12) XXL(13/14)



10/100

BL



NE



RY



VE



RO



BI



AY 7465 SUNRISE

T-shirt da uomo girocollo manica corta, colletto in costina misto spandex da 1.5 cm con cucitura ribattuta sul davanti, nastro di rinforzo da spalla a spalla in colore a contrasto visibile nel colletto, cuciture stretch, cucita lateralmente. 100% Cotone.



Cotone - 190 g/mq



XS - S - M - L - XL - XXL - 3XL



5/100

AY 7465-BI SUNRISE WHITE

T-shirt da uomo girocollo manica corta, colletto in costina misto spandex da 1.5 cm con cucitura ribattuta sul davanti, nastro di rinforzo da spalla a spalla in colore a contrasto visibile nel colletto, cuciture stretch, cucita lateralmente. 100% Cotone.



Cotone - 190 g/mq



XS - S - M - L - XL - XXL - 3XL
4XL - 5XL



5/100



BI



BL



NE



RY

AY 7453 FLAG

T-shirt uomo, 100% cotone pettinato, colletto e bordo maniche in Rib con tricolore, struttura tubolare, collo nastrato tricolore.



Cotone - 150 g/mq



S - M - L - XL - XXL - XXXL



5/100



AY 7452 CONTRAST

T-shirt uomo cotone pettinato. Bicolore, girocollo a costina rinforzata, nastro di rinforzo interno da spalla a spalla, 100% cotone pettinato.



Cotone - 150 g/mq



S - M - L - XL - XXL



6/60



AY 7470
T-SHIRT
SUBLIMATION

T-shirt giro collo manica corta raglan, in tessuto tecnico traspirante asciugatura rapida, adatta alla sublimazione. Etichetta rimovibile.



Poliestere Piquet - 150 g/mq
S - M - L - XL - XXL - 3XL
(disponibile su richiesta anche
donna e bambino)



5/50



AY 7464 V-NECK LADY

T-shirt collo a V manica corta sfiancata da donna, colletto in costina misto spandex da 1,5 cm con cucitura ribattuta sul davanti, nastro di rinforzo da spalla a spalla in colore a contrasto visibile nel colletto, cuciture stretch, cucita lateralmente.



Cotone Jersey - 150 g/mq



XS - S - M - L - XL



5/100



T-SHIRT

AY 7466
V-NECK

T-SHIRT UOMO cotone, collo a V, mezza manica.



Cotone - 150 g/mq



S - M - L - XL - XXL - XXXL



5/100



NE



RO



BI



BL



AY 7442 MODA

T-shirt donna elasticizzata cotone
pettinato, taglio sfiancato, colletto
ribassato.



Cotone 95% / Spandex 5%
210 g/mq



S - M - L - XL



6/60

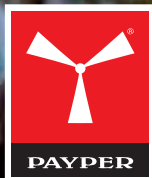

BI



NE



RO



T-SHIRT

AY 7448
ANNA

T-shirt donna collo v elasticizzata cotone pettinato, taglio sfiancato, colletto ribassato.



Cotone 95% / Spandex 5%
210 g/mq



S - M - L - XL



6/60



AY 7500 PINETA

T-shirt uomo manica lunga. In cotone 100% pettinato, girocollo a costina, nastro di rinforzo alto 2,3cm da spalla a spalla, cucitura ribattuta sul davanti del collo, struttura tubolare che assicura la indeformabilità del capo.



Cotone - 165 g/mq



S - M - L - XL - XXL - XXXL



5/100



NE



BI

AY 7501 PINETA LADY

T-shirt girocollo manica lunga da donna, colletto e polsino in costina misto spandex con cucitura ribattuta sul davanti, nastro di rinforzo da spalla a spalla, cucitura laterale per una migliore vestibilità.



Cotone Jersey% - 165 g/mq



S - M - L - XL



5/100

T-SHIRT

BI



NE



RY



RO

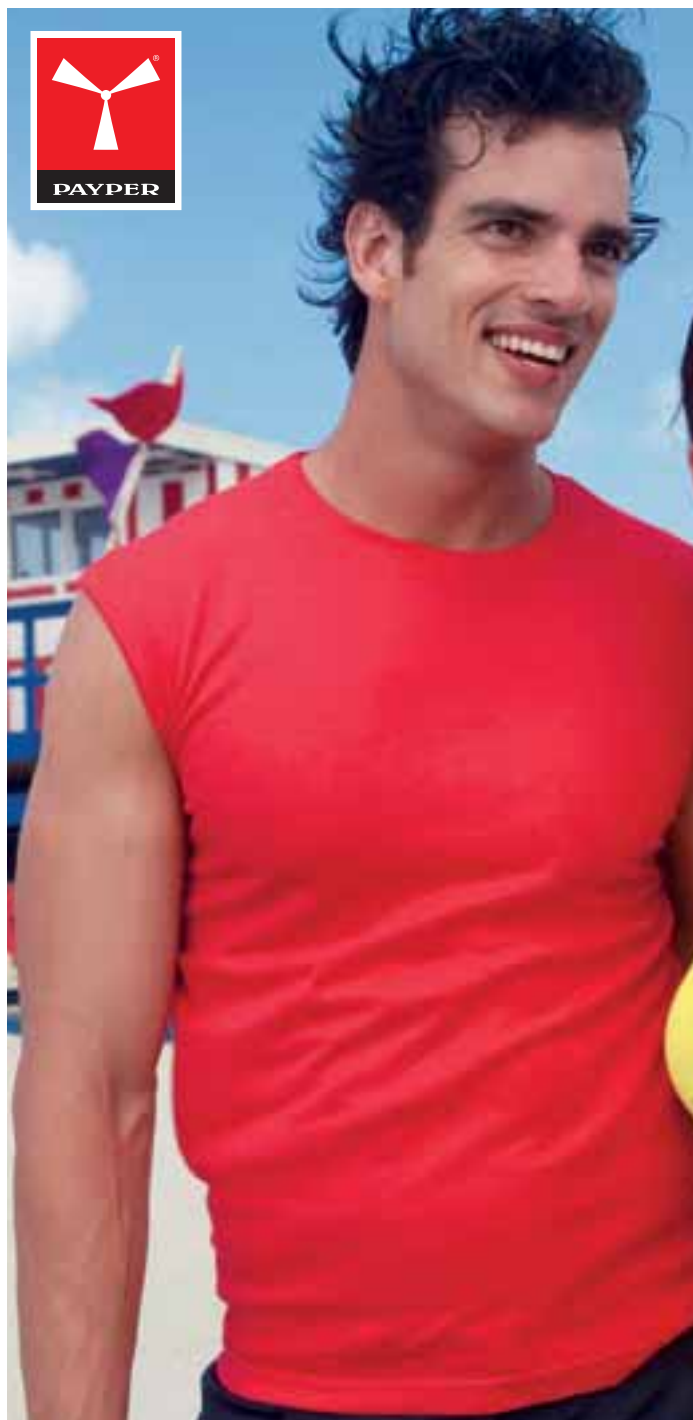

AY 7493 SHORE

Canotta uomo, spalla larga. Girocollo a costina rinforzata, nastro di rinforzo interno da spalla a spalla.



Cotone - 165 g/mq



S - M - L - XL - XXL



5/100

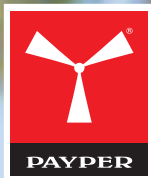

**AY 7496
LOOK**

Canotta donna, cotone. Taglio sfiancato.



T-SHIRT

 Cotone - 190 g/mq

 S - M - L - XL

 5/100

RO



NE



AZ



AY 7428 FASHION

Canotta donna. Taglio sfiancato a spalla
larga con scollo a V, colletto a polo bianco.



Cotone 95% / Spandex 5%
210 g/mq



S - M - L - XL



6/24

promosolution 2020|2021

T-SHIRT

POLO

FELPE

PILE

GIUBBINI

GILET

WORK

CAPPELLI





**AY 7440
VENICE**

Polo Uomo 3 bottoni in tinta, cotone piquet, mezza manica, collo e giro maniche a costina rinforzata, spacchi laterali, 100% cotone piquet pettinato, colori reattivi.



Cotone Piquet pettinato - 200 g/mq

XS - S - M - L - XL - XXL - XXXL
(colore Blu, Bianco, Arancione, Royal, Grigio Melange, Nero e Smoke disponibili anche 4XL - 5XL)

5/50



POLO



7439
VENICE LADY

Polo 4 bottoni mezza manica, cotone piquet, collo e giromanica a costina rinforzata, spacchi laterali, colori reattivi, taglio sfiancato.



Cotone Piquet - 200 g/mq



S - M - L - XL



5/50



RY

RO



AR



JG



BL



NE



SM



ML



BI



AY 7404
ROME

Polo a manica corta con 3 bottoni in tinta effetto perlato, spacchetti laterali, cuciture del collo coperte con nastro in tinta.



Cotone Piquet - 180 g/mq



XS - S - M - L - XL - XXL - 3XL
(4XL - 5XL disponibili solo su colori Bianco-Blu-Royal-Nero-Smoke)



5/50



POLO



BI/BL



BL/BI



NE/BI

**AY 7420
VELA**

Polo manica corta a 3 bottoni in tinta con inserto bicolore ai fianchi, colletto e bordo manica con profilo a contrasto, bordo manica a costine, cuciture del collo coperte, nastro di rinforzo laterale.



Cotone Piquet - 210 g/mq



S - M - L - XL - XXL



6/24



**AY 7412
PRESTIGE**

Polo a manica corta a 4 bottoni in tinta, colletto modello camicia, taschino frontale, inserti in popeline celeste su interno collo, spacchetti laterali e nella apertura frontale, 100% cotone piquet finissimo pettinato di altissima qualità.



Cotone Piquet - 190 g/mq



S - M - L - XL - XXL - XXXL



5/25



BI



BL



BA



HC



FX



EG

AY 7413 GLAMOUR LADY

Polo taglio sfiancato manica corta a 5 bottoni in tinta, colletto modello camicia, inserti in popeline celeste su interno collo, spacchetti laterali e nella apertura frontale 100% cotone piquet finissimo pettinato di altissima qualità.



Cotone Piquet - 190 g/mq



S - M - L - XL



5/25

BL/BI



RY/BI



VI/BI



RO/BI



AR/BI



NE/BI



ML/BL



BI/BL



**AY 7433
CAMBRIDGE**

Polo Uomo, 3 bottoni mezza manica, collo e giromanica a contrasto, spacchi laterali, interno collo in oxford, occhielli sotto braccio.



Cotone jersey - 175 g/mq



S - M - L - XL - XXL - XXXL



5/25



POLO



NE/BI



BI/BL



RY/BI



BL/BI



AR/BI



RO/BI

**AY 7430
LEEDS**

Polo Donna, 6 bottoni mezza manica, colletto e bordo maniche in rib con riga contrasto, spacchi laterali, interno collo in oxford, interno patta bottoni in oxford, occhielli sotto braccio.



Cotone Jersey - 175 gmq
S - M - L - XL
5/25

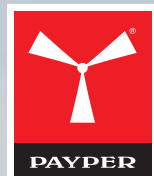

**AY 7414
MEMPHIS**

Polo Uomo manica corta a tre bottoni in tinta ad effetto perlato, colletto da un lato in tinta dall'altro lato con colori a contrasto a fasce, visibile solo se alzato, interno abbottonatura collo e spacchetti laterali con contrasto, bordo manica dx con fine inserto nei colori del collo, bordo manica a costine, cuciture del collo coperte con nastro a contrasto, nastro di rinforzo laterale, 100% cotone jersey pettinato tintura reactive.



Cotone jersey - 175 g/mq



S - M - L - XL - XXL - 3XL



5/25



BI



NE



SM



RY



BL

AY 7415 MEMPHIS LADY

Polo Donna, sfiancata manica corta a sei bottoni in tinta ad effetto perlato, colletto da un lato in tinta dall'altro lato con colori a contrasto a fasce, visibile solo se alzato, interno abbottonatura collo e spacchetti laterali con contrasto, bordo manica dx con fine inserto nei colori del collo, bordo manica a costine, cuciture del collo coperte con nastro a contrasto, nastro di rinforzo laterale. 100% cotone jersey pettinato tintura reactive.



Cotone Jersey - 175 g/mq



S - M - L - XL



5/25

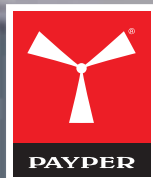

**AY 7438
SKIPPER**

Polo Uomo, 3 bottoni mezza manica, collo e giromanica a contrasto, spacchi laterali, 100% cotone piquet pettinato, colori reattivi.



Cotone Piquet - 210 g/mq



S - M - L - XL - XXL



5/25



BL/BI



RY/BI



NE/BI



GR/AR



BI/BL



RO/BI

POLO

AY 7437 SKIPPER LADY

Polo Donna 5 bottoni mezza manica, collo e giromanica a contrasto, spacchi laterali, taglio sfiancato, 100% cotone piquet pettinato, colori reattivi.



Cotone Piquet - 210 g/mq



S - M - L - XL



5/25

RY



NE



ML



BI



BL



RO



VM



**AY 7421
NATION**

Polo Uomo a manica corta a tre bottoni in tinta ad effetto perlato, colletto da un lato in tinta, dall'altro lato a contrasto con tricolore visibile solo se alzato, bordo manica dx con fine inserto tricolore in contrasto, bordo manica a costine, spacchetti laterali con tricolore, cuciture del collo coperte con nastro in jersey tricolore, nastro di rinforzo laterale. 100% cotone piquet pettinato tinto in filo a 60° con colori reattivi.



Cotone Piquet - 210 g/mq



S - M - L - XL - XXL - XXXL



5/25



POLO

**AY 7422
NATION LADY**

Polo Donna sfiancata a manica corta a 5 bottoni in tinta ad effetto perlato, colletto da un lato in tinta, dall'altro lato a contrasto con tricolore visibile solo se alzato, bordo manica dx con fine inserto tricolore in contrasto, bordo manica a costine, spacchetti laterali con tricolore, cuciture del collo coperte con nastro in jersey tricolore, nastro di rinforzo laterale. 100% cotone piquet pettinato tinto in filo a 60° con colori reattivi.



Cotone Piquet - 210 g/mq



S - M - L - XL



5/25



**AY 7416
NAUTIC**

Polo Uomo 3 Bottoni, manica corta, colletto con righe a contrasto interne e righe fluorescenti esterne, spacchetti e cuciture collo coperte con nastro fluo.



Cotone Jersey - 165 g/mq



S - M - L - XL - XXL - XXXL



5/25



BL



POLO

BI



RY



AY 7418 NAUTIC LADY

Polo Donna, 6 Bottoni, manica corta, colletto con righe a contrasto interne e righe fluorescenti esterne, spacchetti e cuciture collo coperte con nastro fluo.



Cotone Jersey - 160 g/mq



S - M - L - XL



5/25

RY



BL



VM



VE



NE



ML



BI



RO



**AY 7434
ITALIA**

Polo 3 bottoni mezza manica, collo e giromanica con rigatura tricolore a contrasto, spacchi laterali, colori reattivi.



Cotone Piquet - 210 g/mq



XXS - XS - S - M - L - XL - XXL - XXXL (Blu Navy anche in TG: 4XL e 5XL)



5/25



POLO

**AY 7505
AVIAZIONE**

Polo Unisex manica lunga a 3 bottoni in tinta, collo e polsino con fine profilo tricolore in contrasto, polsino a costine, spacchetti laterali, cuciture del collo coperte, nastro di rinforzo laterale. Materiale: 100% cotone piquet pettinato tinto in filo a 60° con colori reattivi.



Cotone Piquet - 210 g/mq



S - M - L - XL - XXL - XXXL
(Blu, Rosso e Bianco anche 4XL e 5XL)



5/25



**AY 7489
VENICE KIDS**

Polo da bambino a manica corta con 3 bottoni in tinta effetto perlato, colletto e bordo manica a costine, spacchetti laterali, cuciture del collo coperte con nastro a contrasto, cuciture stretch, nastro di rinforzo laterale, rinforzo sagomato retrocollo.



Cotone - 200 g/mq



S(5/6) - M(7/8) - L(9/10)
XL(11/12) - XXL(13/14)



5/50



POLO

AY 7514
FLORENCE KIDS

Polo a manica lunga con apertura a 3 bottoni in tinta, spacchetti laterali e lunetta dietro collo.



Cotone - 210 g/mq



S(5/6) - M(7/8) - L(9/10)
XL(11/12) - XXL(13/14)



5/25



**AY 7515
FLORENCE**

Polo Uomo manica lunga in cotone piquet con apertura a 3 bottoni in tinta, spacchetti laterali e lunetta dietro collo.



Cotone - 210 g/mq



S - M - L - XL - XXL - 3XL - 4XL - 5XL



5/25



POLO

**AY 7516
FLORENCE LADY**

Polo Donna manica lunga in cotone piquet, con apertura a 4 bottoni in tinta, spacchetti laterali e lunetta dietro collo.



Cotone Piquet - 210 g/mq



XS - S - M - L - XL



5/25



BI

NE

RO



BL

RY



**AY 7509
LONG NATION**

Polo Uomo manica lunga 3 bottoni,
100% cotone nido d'ape, colletto in tinta
da un lato e tricolore dall'altro, spacchetti
laterali, polsini elasticizzati.



Cotone - 210 g/mq



S - M - L - XL - XXL - XXXL



5/25

promosolution 2020 | 2021

T-SHIRT

POLO

FELPE

PILE

GIUBBINI

GILET

WORK

CAPPELLI





ML



SM



NE



BI



BL



RY



VE



RO



**AY 7521
MISTRAL+**

Felpa Girocollo, manica raglan, cucitura estetica a V al collo, polsini e vita in costina elasticizzata, cuciture rinforzate.



Garzato 70% + Poliestere 30%
300 g/mq



S - M - L - XL - XXL - 3XL



5/20



FELPE

AY 7522
ORLANDO

Felpe da uomo, girocollo, cucitura estetica a V al collo, manica a giro, polsini e vita in costina elasticizzata, cuciture rinforzate.



Garzato 70% + Poliestere 30%
280 g/mq



XS - S - M - L - XL - XXL - 3XL



5/20



**AY 7525
MIAMI+**

Felpa a mezza zip di metallo, polsini e vita in costina elasticizzata, doppia cucitura al collo, alle maniche e in vita e nastro di rinforzo al collo.



Cotone 70% + Poliestere 30%
300 g/mq



XS - S - M - L - XL - XXL - XXXL
(Blu-Arancio-Nero-Royal-Grigio
disponibili anche 4XL e 5XL)



5/20

NE



SM



ML



BL



RY



RO



AR



FELPE

AY 7527 CANADA

Felpe mezza zip in tinta, polsini e vita in costina elasticizzata, cuciture rinforzate.



Cotone 70% + Poliestere 30%
300 g/mq



S - M - L - XL - XXL - XXXL



5/20



BI



NE



ML



BL



RY



VE



RO



AR

AY 7545 PANAMA+

Felpe da uomo a manica raglan e zip intera in tinta, doppio cursore in metallo; due tasche con zip coperte, polsini e vita in costina elasticizzata, cuciture rinforzate.



Garzato 70% + Poliestere 30%
300 g/mq



XS - S - M - L - XL - XXL - XXXL
(Blu-arancio-grigio anche 4XL-5XL)



5/20



FELPE



NE



RO



ML



SM



RY



BL

AY 7542 HOUSTON

Felpa con zip intera di plastica in tinta, cursore in metallo; polsini e vita in costina elasticizzata, cuciture rinforzate. Nastro di rinforzo interno collo in tinta.



Cotone 70% + Poliestere 30%
280 g/mq



XS - S - M - L - XL - XXL - 3XL



5/20

BL



RY



NE



BI



RO





GI



**AY 7530
SYDNEY**

Felpe Full zip con doppio cursore.

-  Cotone 70% + Poliestere 30%
300 g/mq
-  S - M - L - XL - XXL - 3XL
-  5/20



FELPE

AY 7532 NAZIONALE

Felpa a zip intera con contrasto tricolore e doppio cursore; colletto in rib con tricolore a contrasto all'interno, due tasche esterne, rib in vita, doppia cucitura al collo, alle maniche e in vita e nastro di rinforzo al collo.



Cotone 70% + Poliestere 30%
280 g/mq



S - M - L - XL - XXL - 3XL



5/20

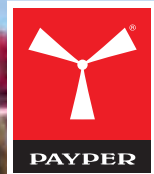

NE



ML



BL



RY



BA



RO



AR



GI



JG



AY 7548 ATLANTA+

Felpa da uomo con manica raglan e cappuccio in tinta con coulisse in corda con cuciture in contrasto e anello in metallo, cucitura estetica a V al collo, tasche a marsupio, taschino con secur zip, polsini e vita in costina elasticizzata, cuciture rinforzate.



Garzato 70% + Poliestere 30%
300 g/mq



S - M - L - XL - XXL - XXXL



5/20



BL



RY



ML



SM



NE



RO



FELPE

AY 7550 TORONTO

Felpa da uomo, cappuccio con coulisse in tinta, cucitura estetica a V al collo, tasche a marsupio, manica a giro, polsini e vita in costina elasticizzata, cuciture rinforzate. Nastro di rinforzo interno collo in tinta.



Garzato 70% + Poliestere 30%
300 g/mq



XS - S - M - L - XL - XXL - 3XL



5/20



AY 7535 DALLAS+

Felpa da uomo con manica raglan, zip intera con doppio cursore e cappuccio in tinta con coulisse e anello in metallo, cuciture in tinta con la felpa, tasche a marsupio con taschino con securzip, polsini e vita in costina elasticizzata. Cuciture rinforzate.



Cotone 70% + Poliestere 30%
300 g/mq



XS - S - M - L - XL - XXL - XXXL
(Blu-Melange-Nero anche 4XL- 5XL)



5/20



RO



ML



NE



SM



BL



RY



AY 7534 PORTLAND

Felpa da uomo, zip intera, cappuccio in tinta con coulisse e anello in metallo, cuciture in tinta con la felpa, tasche a marsupio, cuciture rinforzate, polsini e vita in costina elasticizzata. Nastro di rinforzo interno collo in tinta.



Cotone 70% + Poliestere 30%
280 g/mq



S - M - L - XL - XXL - 3XL



5/20



BI

NE



BL



SM



RY



**AY 7552
HAWAII+**

Felpa da uomo con manica raglan, zip intera con doppio cursore e cappuccio in tinta, coulisse con cuciture in tinta con la felpa e anello in metallo, tasche a marsupio con taschino con secur-zip, polsini e vita in costina elasticizzata. Cuciture rinforzate.



Cotone 80% + Poliestere 20%
260 g/mq



S - M - L - XL - XXL - XXXL



5/20

promosolution 2020|2021

T-SHIRT

POLO

FELPE

PILE

GIUBBINI

GILET

WORK

CAPPELLI





BI



RO



AR



GI



MI



NE



BL



RY



VE

AY 7560 DOLOMITI +

Pile a mezza zip con coulisse in vita, finitura al collo per un miglior posizionamento se portato sopra ad un altro capo dotato di colletto, elastici stringi polso, due tasche retinate internamente con zip di chiusura.



Poliestere - 280 g/mq



XS - S - M - L - XL - XXL - 3XL - 4XL - 5XL



5/20



NE/GR



GR/AR



BL/RV



RV/NE



RO/NE



VE/VA

PILE

**AY 7561
ASPEN +**

Maglia Pile bicolore full zip, 3 tasche esterne con zip, elastici stringipolso, coulisse in vita, colletto interno e fianchi in contrasto.



Pile Antipilling - 280 g/mq



S - M - L - XL - XXL - 3XL





5/20



**AY 7566
NEPAL**

Pile full zip con manica a giro, zip in tinta in nylon con cursore singolo, due tasche con zip, elastico stringi polso e fondo non sagomato.

-  Poliestere - 280 g/mq
-  XS - S - M - L - XL - XXL - 3XL
-  5/20

promosolution 2020|2021

T-SHIRT

POLO

FELPE

PILE

GIUBBINI

GILET

WORK

CAPPELLI



NE



GR



BI



RY



BL



RO



VE



MA



AY 7260 NORTH 2.0

Giubbino in 100% nylon, con rib elasticizzato in vita e ai polsi, due tasche esterne con zip coperta; interno imbottito e micropile nel colletto e nella schiena, 1 tasca interna porta smartphone con cerniera e passaggio per cuffie, zip al petto e sul fondo schiena per agevolare stampe e ricami.



Nylon Taslon 228T - 105 g/mq



XS - S - M - L - XL - XXL - 3XL
(4XL - 5XL disponibili solo in
Blu Navy e Nero)



1/10



**AY 7527
NEW SPORT**

Giubbino in nylon, fullzip, interno in pile, 3 tasche esterne, 2 tasche interne, coulisse in vita, zip per agevolare stampe e ricami, cappuccio richiudibile nel colletto.



Nylon - 185 g/mq



S - M - L - XL - XXL



1/10

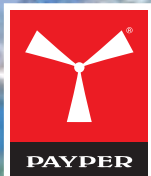

BL

NE



AY 7255 NORTH R 2.0

Giubbino con rib elasticizzato in vita e ai polsi, cerniera in contrasto, due tasche esterne con zip coperta; interno imbottito e micropile nel colletto e nella schiena; 1 tasca interna con cerniera e passaggio per cuffie smartphone, zip al petto e sul fondo schiena per agevolare stampe e ricami.



Nylon Taslon 228T - 105 g/mq



XS - S - M - L - XL - XXL - 3XL



1/10



BL



NE



GIUBBINI

AY 7254 SAILING R 2.0

Giubbino con cappuccio, elastico su fondo, polsi con elastico e stringi polsi gommati, cerniera in contrasto, due tasche esterne con zip coperta; interno imbottito e micropile nella schiena, 1 tasca interna con cerniera e passaggio per cuffie smartphone, zip al petto e sul fondo schiena per agevolare stampe e ricami.



Nylon Taslon 228T- 105 g/mq



XS - S - M - L - XL - XXL - 3XL



1/10

NE



GR



RY



BL



AY 7230 ESCAPE

Giubbino con maniche staccabili in pongee 240T, stringi polsi regolabile ed elastico, con cappuccio richiudibile nel colletto; due ampie tasche frontali LOCK SYSTEM, due tasche laterali, porta cellulare al petto. Interno imbottito e cerniera interna nella schiena per facilitare stampe/ ricami.



Pongee 240T - 180 g/mq



XS - S - M - L - XL - XXL - 3XL
(4XL - 5XL disponibili solo in
Blu Navy e Nero)



1/10



BL



NE



GIUBBINI

**AY 7236
FREETIME**

Giubbino/piumino da uomo con cappuccio, zip SBS 5mm in plastica con cursore in metallo, fine bordino ai polsi e in vita, due tasche esterne. Interno: imbottito di poliesteri effetto piuma, due tasche.



Nylon 320T - 58 g/mq



XS - S - M - L - XL - XXL - 3XL



1/10



BL



GR



NE



AY 7233 RENEGADE

Giubbino UNISEX con elastico in fondo e stringi polsi in pongee 240T, cappuccio richiudibile nel colletto; 2 ampie tasche frontali LOCK-SYSTEM, 2 tasche laterali, porta cellulare al petto, interno imbottito, cerniera nella schiena per facilitare stampe/ricami.



Pongee 240T - 180 g/mq



XS - S - M - L - XL - XXL - 3XL



1/10



AY 7253 GALAXY

Giubbino trapuntato con retro sagomato e imbottitura trapuntata, rifinito con fodera ad alta densità, interno colletto in pile. Due ampie tasche con zip, tasca portasmartphone al petto e una tasca interna. Cappuccio richiudibile nel colletto.



Poliestere - Pongee PVC 190T
175 g/mq



S - M - L - XL - XXL - 3XL



1/10



AY 7252 ORION

Giubbino da uomo, maniche staccabili, retro sagomato, zip 8 mm in plastica con cursore in metallo, due ampie tasche esterne con zip, ampia tasca la petto porta Smart-Phone, anello portabadge, piping reflex al petto e sulla schiena. Interno: imbottitura trapuntata e rifinita con fodera ad alta densità, interno colletto in pile, una tasca.



Poliestere - Pongee PVC 190T
175 g/mq



S - M - L - XL - XXL - 3XL - 4XL - 5XL



1/10



SM/NE





NE/SG



BL/RV

**AY 7234
RENEGADE MID**

Giubbino a 3/4 da uomo, zip 8mm in plastica con cursore in metallo, cappuccio richiudibile nel colletto, elastico e stringi polsi, due ampie tasche frontali LOCK-SYSTEM, due tasche laterali, porta cellulare al petto. Interno: imbottito, zip per agevolare stampe e ricami.

-  Poliestere - 200 g/mq
-  XS - S - M - L - XL - XXL - 3XL
4XL - 5XL
-  1/10

BL/RO



BL/RV



NE/SG



GR/NE



AY 7251 FIGHTER 2.0

Giubbino imbottito sagomato con cappuccio a scomparsa e maniche staccabili, due ampie tasche frontali con zip e due tasche con patta brevetto Lock System, entrambe inclinate per agevolare l'ingresso delle mani, una tasca al petto porta smart phone e anello portabadge, interno pile in contrasto su schiena e collo, una tasca interna, zip interna per agevolare stampe e ricami, due bande riflettenti su tasca al petto e schiena per una maggior visibilità/sicurezza.



Poliestere - Pongee Ripstop 240T
180 g/mq



XS - S - M - L - XL - XXL - 3XL
4XL - 5XL



1/10



GR



BL

**AY 7248
WARM 2.0**

Giubbino trapuntato in Techno 80% Poliestere e 20% cotone, con maniche staccabili e con retro sagomato e imbottitura rifinita con fodera ad alta densità, interno colletto in pile. Ampia tasca al petto porta smart-phone, porta penne e due bande riflettenti, anello porta badge, due ampie tasche con zip sul davanti e una tasca interna.



Techno 80% Poliestere 20%
170 g/mq



S - M - L - XL - XXL - 3XL
4XL - 5XL



1/10



SM/NE



NE/SG



BL/RO



RO/BL



AY 7229
OREGON
SOFT-SHELL

Giubbino imbottito da uomo, con cappuccio, zip intera SBS in plastica con cursore in metallo "autolock", due tasche esterne con zip, una tasca interna con zip.



Nylon 78% - Elastane 22%
330 g/mq



XS - S - M - L - XL - XXL - 3XL



1/10



RY



SG



RO



NE

**AY 7232
PERTH
SOFT-SHELL**

Giacca ergonomica da uomo a due strati con trattamento water repellent, manica a giro, zip lunga SBS nastrata, fine bordino elasticizzato ai polsi, 2 tasche laterali con zip.



Poliestere - 280 g/mq



S - M - L - XL - XXL - 3XL



1/10



AY 7228 GIACCA SOFT-SHELL

Giacca con cappuccio staccabile, coulisse elasticizzata, maniche con regolazioni a velcro, tasca sul petto, due tasche anteriori con zip. Outshell: 96% soft shell e poliestere 4% Elastane. Membrana TPU 8000 mm impermeabile, traspirabilità di 1000 g/mq/24h traspirabilità 3. Fodera in pile.



Poliestere 96% - Elastane 4%



S - M - L - XL - XXL - 3XL



1/10



RY



BL



NE



RO



GR

GIUBBINI

AY 7223 GALE SOFT-SHELL

Giacca UNISEX in 100% poliestere, giacca ergonomica a zip intera, con cappuccio fisso, polsini regolabili con stringi polso, due tasche laterali con zip.



Poliestere - 320 g/mq



S - M - L - XL - XXL - 3XL



1/10

BL



RY



RO



NE



AY 7267 RAIN JACKET

Giacca cerata a collo alto con cerniera lunga. Cappuccio ripiegabile a scomparsa nel colletto con cordoncini. Due tasche con copritasca e cerniera. Polsini elastici. Parte inferiore con cordoncini regolabili e stopper.



Poliestere - 70gr/mq



S - M - L - XL - XXL



1/50

promosolution 2020|2021

T-SHIRT

POLO

FELPE

PILE

GIUBBINI

GILET

WORK

CAPPELLI





AR



GI



**AY 7590
PADDOCK**

Giubbino bicolore in alta visibilità con bande riflettenti, zip intera con patta, cappuccio richiudibile nel colletto, vita e polsini elasticizzati, due ampie tasche frontali con patta e velcro, portacellulare e anello di aggancio per porta badge. Interno: imbottito, una tasca con velcro, cuciture termonastrate.



Poliestere Spalmato Poliuretano
180 g/mq



S - M - L - XL - XXL - 3XL



1/10



AR



GI



RETRO

WORK

AY 7589 YARD

Parka fisso bicolore in alta visibilità con bande riflettenti, zip intera con patta, cappuccio richiudibile nel colletto, polsini in RIB elasticizzato, due tasche frontali con patta, un portasmartphone e anello di aggancio per portabadge. Interno: imbottito, una tasca interna con velcro, cuciture termonastrate.



100% Poliestere Spalmato
Poliuretano, 300D Oxford 100%
PI/Pu 190T Taffetà. - 180 gr/mq



S - M - L - XL - XXL - 3XL





1/10





**AY 7596
CHARTER WINTER**

Pantalone uomo, invernale, in alta visibilità bicolore con bande riflettenti, elastici laterali e passanti in vita, chiusura con zip e bottone in plastica, due tasche anteriori a taglio classico, tasca laterale LOCK SYSTEM, porta metro, due tasche posteriori una aperta e una con patta e velcro. Cuciture a contrasto, cavallo e interno gamba a triplo ago.

-  Satin 80% Poliestere
Cotone 20% - 295 gr/mq
-  S - M - L - XL - XXL - 3XL
-  1/20



**AY 7597
CHARTER**

Pantalone uomo, multistagione, in alta visibilità con bande riflettenti, elastici laterali e passanti in vita, chiusura con zip e bottone in plastica, due tasche anteriori a taglio classico, tasca laterale LOCK SYSTEM, porta metro, due tasche posteriori una aperta e una con patta e velcro. Cuciture a contrasto, cavallo e interno gamba a triplo ago.

-  Cotone 50% Poliestere 50%
250 gr/mq
-  S - M - L - XL - XXL - 3XL
4XL - 5XL
-  1/20

**AY 7591
HI-VI RAINSET**

Completo anti pioggia in alta visibilità con bande riflettenti, composto da giacca con zip, cappuccio richiudibile nel colletto, fondo manica dritto, retinatura sulla schiena. Pantalone con elastico in vita e due tasche. Imbusto singolo con zip.

-  Oxford 100% Poliestere
130 g/mq
-  M - L - XL - XXL - 3XL
-  1/10



GI

AR



GI



**AY 7592
GILET ALTA VISIBILITA'**

Gilet in alta visibilità multitasche con bande rifrangenti, chiusura frontale con zip, due tasche frontali con patta di chiusura una tasca al petto con patta, taschino portapenna, anello per aggancio portabadge. Un portasmartphone e anello di aggancio per portabadge. Interno: imbottito, una tasca interna con velcro, cuciture termonastrate.



100% Poliestere



S - M - L - XL - XXL - 3XL



1/10

**AY 7225
GILET ALTA VISIBILITA'**

Certificato EN 471, chiusura con velcro.



Poliestere 150 D



M - XL - XXL



1/50



1 TOMAIA UPPER

Setacciato microforato, traspirante e impermeabile, in tessuto sintetico di ultima generazione e trattamento speciale. Strada di carboni in microbolle microforate per una maggiore aereazione e un'ottima idrorepellenza. Integrale di carboni attivi e microbolle per un'ulteriore protezione dall'inquinamento e dagli odori. Integrale di carboni attivi e microbolle per un'ulteriore protezione dall'inquinamento e dagli odori.

Shoey, breathable and waterproof upper made of high quality synthetic and ultra-innovative. Treated with carbon layers for extra breathability and odor protection. Carbonized carbon layers for extra breathability and odor protection. Carbonized carbon layers for extra breathability and odor protection.

2 FODERA LINING

La fodera interna è impermeabile, traspirante e pulita in ogni momento e durante l'uso.

Shoey is a lining (including the toe area) made of breathable synthetic material to breathe.

3 OCCHIELLI METALFREE METAL-FREE EYELETS

I occhiali conferiscono elasticità e resistenza all'usura, senza compromettere la qualità della camminata.

The practice metal-free eyelets facilitate a better walking motion, ensuring a pleasant effort.

4 PARATACCO HEEL GUARD

Componente protettivo in polietilene con gomme perpendicolari, riduce il rischio di strisciare.

Protective heel guard in special rubber with wear-resistant compound and self-heal power.

5 TOPALU.CAP

Decorazione personalizzabile con i colori personalizzati. Leggero e ultraleggero, con il 90% di riciclaggio. La tomaia del calzino, in feltro, protegge e protegge il piede e il tallone. Integrale di carboni attivi e microbolle per un'ulteriore protezione dall'inquinamento e dagli odori.

The sensitive top in the color variations, light and ultralight. It is highly resistant to impacts up to 200 mmHg. The high pressure and temperature design for the top allows maximum heat relief, for top-level comfort and safety.

6 PLANTARE ORTHOLITE® ARCH SUPPORT

Il plantare Ortholite® è un sistema di supporto archi che supporta l'arco plantare. Completamente lavabile, non danneggia i calzini, favorisce la circolazione e il riposo.

The removable Ortholite® ARCH SUPPORT arch support with benefits. It is soft, light and easy to clean. It is highly resistant to impacts up to 200 mmHg. It also has a special design for the heel and the forefoot.

7 SOLETTA ANTIPERFORAZIONE PERFORATION-PROOF INSOLE

Soletta in carboni attivi, protegge l'antiperforazione, ad alta elasticità e alta resistenza.

Shoey is made of carbonized active carbon with high performance and maximum breathability.

8 SOTTOPUNTALE UNDER-TOE

Sottopuntale in polietilene a densità controllata per aumentare il movimento e l'elasticità.

Heelguard designed under the shoe to provide maximum flexibility and resistance.

9 SHANK ANTITORSIONE ANTI-TORSION SHANK

Elemento in carboni attivi che protegge il piede e il tallone. Integrale di carboni attivi e microbolle per un'ulteriore protezione dall'inquinamento e dagli odori.

A highly resistant and ultralight shank made of high quality synthetic and ultra-innovative.

10 INTERSUOLA MID-SOLE

Intersuola con carboni attivi e microbolle, protegge il piede e il tallone. Integrale di carboni attivi e microbolle per un'ulteriore protezione dall'inquinamento e dagli odori.

The ultralight, shank made of high quality synthetic and ultra-innovative. It is highly resistant to impacts up to 200 mmHg. It also has a special design for the heel and the forefoot.

11 MASTER BALANCE

Il Master Balance è un sistema di bilanciamento che supporta il piede e il tallone. Integrale di carboni attivi e microbolle per un'ulteriore protezione dall'inquinamento e dagli odori.

The effective Master Balance balancing system in the shoe, with high elasticity and maximum energy. It is highly resistant to impacts up to 200 mmHg. It also has a special design for the heel and the forefoot.

12 SUOLA X TRAIL GRIP X TRAIL GRIP SOLE

Suola in carboni attivi e microbolle, protegge il piede e il tallone. Integrale di carboni attivi e microbolle per un'ulteriore protezione dall'inquinamento e dagli odori.

The highly resistant and ultralight sole made of high quality synthetic and ultra-innovative. It is highly resistant to impacts up to 200 mmHg. It also has a special design for the heel and the forefoot.

LOW PELLE

Scarpa di sicurezza bassa da uomo, tomaia in pelle idrorepellente e traspirante, fodera interna (per tutta la superficie interna) traspirante e resistente all'abrasione, 6+6 occhielli metalfree, paratacco in grana pampas con inserto riflettente, puntale in alluminio pressofuso, plantare estraibile Ortholite X40 016 ESD, soletta in lamina tessile certificata antiperforazione, cambrione antitorsione, sottopuntale a ferro di cavallo, intersuola in poliuretano ultraleggero ESD, ammortizzatore MASTER BALANCE in PU polietere ad alta tenacità e densità bilanciata, suola XTRAIL GRIP in TPU ESD con paratacco e parapunta.



Tutto Fiore Bovino



39 - 40 - 41 - 41,5 42 42,5 - 43 - 43,5 - 44 44,5 - 45 - 46 - 47 - 48



1



MID PELLE

Scarpa di sicurezza medium da uomo, tomaia in pelle idrorepellente e traspirante, fodera interna (per tutta la superficie interna) traspirante e resistente all'abrasione, 8+8 occhielli metalfree, paratacco in grana pampas con inserto riflettente, puntale in alluminio pressofuso, plantare estraibile Ortholite X40 016 ESD, soletta in lamina tessile certificata antiperforazione, cambrione anti-torsione, sottopuntale a ferro di cavallo, intersuola in poliuretano ultraleggero ESD, ammortizzatore MASTER BALANCE in PU polietere ad alta tenacità e densità bilanciata, suola XTRAIL GRIP in TPU ESD con paratacco e parapunta.



Tutto Fiore Bovino



39 - 40 - 41 - 41,5 42 42,5 - 43 - 43,5 - 44 44,5 - 45 - 46 - 47 - 48



1





GI



RO



SM



CI



NE



SM/BI



TB

LOW NABUK

Scarpa di sicurezza bassa da uomo, tomaia in pelle idrorepellente e traspirante, fodera interna (per tutta la superficie interna) traspirante e resistente all'abrasione, 6+6 occhielli metalfree, paratacco in grana pampas con inserto riflettente, puntale in alluminio pressofuso, plantare estraibile Ortholite X40 O1.6 ESD, soletta in lamina tessile certificata antiperforazione, cambrione antitorsione, sottopuntale a ferro di cavallo, intersuola in poliuretano ultraleggero ESD, ammortizzatore MASTER BALANCE in PU poliuretano ad alta tenacità e densità bilanciata, suola XTRAIL GRIP in TPU ESD con paratacco e parapunta.



Fiore Bovino



39 - 40 - 41 - 41,5 - 42 - 42,5 - 43 - 43,5 - 44 - 44,5 - 45 - 46 - 47 - 48



1

GI



NE



TB



CI



SM/SM



RO



SM/BI



MID NABUK

Scarpa di sicurezza medium da uomo, tomaia in pelle idrorepellente e traspirante, fodera interna (per tutta la superficie interna) traspirante e resistente all'abrasione, 8+8 occhielli metalfree, paratacco in grana pampas con inserto riflettente, puntale in alluminio pressofuso, plantare estraibile Ortholite X40 O1.6 ESD, soletta in lamina tessile certificata antiperforazione, cambrione anti-torsione, sottopuntale a ferro di cavallo, intersuola in poliuretano ultraleggero ESD, ammortizzatore MASTER BALANCE in PU poliuretano ad alta tenacità e densità bilanciata, suola XTRAIL GRIP in TPU ESD con paratacco e parapunta.



Fiore Bovino



39 - 40 - 41 - 41,5 - 42 - 42,5 - 43 - 43,5 - 44 - 44,5 - 45 - 46 - 47 - 48



1



KA



NE



BL



SG

LOW SCAMOSCIATA

Scarpa di sicurezza bassa da uomo, tomaia in crosta traforata idrorepellente e traspirante, fodera interna (per tutta la superficie interna) traspirante e resistente all'abrasione, 1+1 occhielli metalfree e 6+6 fori passalacci rinforzati, inserti riflettenti nel paratacco e nel lato esterno della punta, puntale in alluminio pressofuso, plantare estraibile Ortholite X40 016 ESD, soletta in lamina tessile certificata antiperforazione, cambrione anti-torsione, sottopuntale a ferro di cavallo, intersuola in poliuretano ultraleggero ESD, ammortizzatore MASTER BALANCE in PU poliuretano ad alta tenacità e densità bilanciata, suola XTRAIL GRIP in TPU ESD con paratacco e parapunta.



Crosta Bovina



39 - 40 - 41 - 41,5 - 42 - 42,5 - 43 - 43,5 - 44 - 44,5 - 45 - 46 - 47 - 48



1

BL



KA/MI



KA/SA



NE



SG/LG



SG/NE



LOW CORDURA

Scarpa di sicurezza bassa da uomo, tomaia in crosta idrorepellente con inserti in tessuto tecnico traspirante, fodera interna (per tutta la superficie interna) traspirante e resistente all'abrasione, 6+6 occhielli metalfree, inserto riflettente nel paratacco, puntale in alluminio pressofuso, plantare estraibile Ortholite X40 016 ESD, soletta in lamina tessile certificata antiperforazione, cambrione antitorsione, sottopuntale a ferro di cavallo, intersuola in poliuretano ultraleggero ESD, ammortizzatore MASTER BALANCE in PU polietere ad alta tenacità e densità bilanciata, suola XTRAIL GRIP in TPU ESD con paratacco e parapunta.



Crosta Bovina + Tessuto Tecnico



39 - 40 - 41 - 41,5 42 42,5 - 43 - 43,5 - 44 44,5 - 45 - 46 - 47 - 48





1





**AY 7315
SPECIALIST**

Camicia uomo con vestibilità leggermente sfiancata, colletto modello italiano, davanti con cannoncino cucito a vista e bottone bianco effetto perlato, polso sagomato a due bottoni e un'asola; dietro con carrè e pinces di ripresa; una tasca tecnica al petto chiusa da patta con bottone e due asole portapenne.

-  130 gr/mq
-  S - M - L - XL - XXL - 3XL
4XL - 5XL
-  1/20

**AY 7337
CHAMBRAY**

Camicia da Lavoro. Manica corta, 2 tasche con chiusura a bottoni.

-  Cotone Chambray - 135 g/mq
-  M - L - XL - XXL - 3XL
-  1/20





WORK



NE



AY 7312 CHEYENNE

Polo uomo in cotone piquet con taschino. Polo a manica corta 3 bottoni in tinta e piping giallo laterale e alle spalle, taschino al petto con porta badge a scomparsa e portapenna, bordo maniche a costine, spacchetti laterali, cuciture del collo coperte e nastro di rinforzo laterale, occhiali sottobraccio.

-  Cotone Piquet - 220 gr/mq
-  S - M - L - XL - XXL
-  6/24



AY 7325 CANYON

Pantalone unisex, mutistagione, elastici laterali e passanti in vita, chiusura con zip e bottone in metallo, due tasche anteriori a taglio classico e una tasca con zip, una tasca laterale LOCK SYSTEM, una doppia tasca lato sinistro porta metro, due tasche posteriori una aperta e una con patta e velcro. Inserti ed impuntare a contrasto, bande reflex su tasca posteriore, cucitura tripla interno gamba.

-  Twill Cotone - 265 g/mq
-  XXS - XS - S - M - L - XL - XXL
3XL - 4XL - 5XL
-  1/20

AY 7318 WORKER SUMMER

Pantalone unisex, estivo, elastici laterali e passanti in vita, chiusura con zip e bottone in plastica, due tasche anteriori a taglio classico, una tasca laterale LOCK SYSTEM, un porta metro, due tasche posteriori una aperta e una con patta e velcro, inserti ed impuntare a contrasto, bande reflex su tasca posteriore, cuciture triple.

-  Cotone 100% - 210 gr/mq
-  XS - S - M - L - XL - XXL
3XL - 4XL - 5XL
-  1/20



BL





NE



AY 7319 WORKER STRETCH

Pantalone unisex, stretch, multistagione, elastici laterali e passanti in vita, chiusura con zip e bottone in plastica, due tasche anteriori a taglio classico, una tasca laterale LOCK SYSTEM, un porta metro, due tasche posteriori una aperta e una con patta e velcro, cuciture cavallo e interno gamba a triplo ago. Inserti ed impuntare a contrasto, bande reflex su tasca posteriore, cuciture triple.

-  Cotone 98% + Elastan 2%
300 gr/mq
-  XS - S - M - L - XL - XXL
3XL - 4XL - 5XL
-  1/20





SM





**AY 7323
WORKER**

Pantalone Tecnico Pantalone multistagione con inserti e impunture a contrasto, elastici laterali e passanti in vita, chiusura con zip e bottone in plastica, cuciture cavallo e interno gamba a triplo ago, due tasche anteriori a taglio classico, la tasca laterale sx con LOCK SYSTEM, porta metro a dx; due tasche sul retro, una con patta di chiusura e una aperta con doppia banda rinfrangente di sicurezza.

-  Cotone - 260 gr/mq
-  XS - S - M - L - XL - XXL
3L - 4XL
-  1/20

**AY 7320
WORKER WINTER**



Pantalone con inserti e impunture a contrasto, elastici laterali e passanti in vita, chiusura con zip e bottone in plastica, cuciture cavallo e interno gamba a doppio ago, due tasche anteriori a taglio classico, la tasca laterale sx con LOCK SYSTEM, porta metro a dx; due tasche sul retro, una con patta di chiusura e una aperta con doppia banda rinfrangente di sicurezza.

-  Satin brushed 100% cotone
350 g/mq
-  XS - S - M - L - XL - XXL - 3XL
4XL - 5XL
-  1/20





**AY 7322
WEST**

Pantalone multitasche uomo in taglio jeans, 1 tascone laterale LOCK SYSTEM con rinforzo interno, 1 tasca con zip, 1 porta metro, 1 porta smartphone, 1 porta martello, 1 taschino porta penne e cutter, chiusura con zip in metallo e bottone, passanti in vita, trattamento stone washed, effetto consumato e délavé; gamba diritta, cuciture filo grosso a contrasto ed a triplo ago interno gamba. DENIM STRETCH

-  72% Denim + 26% Pol + 2% Elastan
280-300 gr/mq
-  42 - 44 - 46 - 48 - 50 - 52
54 - 56/58 - 60/62 - 64/66
68/70 - 72/74
-  1/20



**AY 7321
SAN FRANCISCO**

Pantalone uomo in taglio jeans a cinque tasche, 1 porta metro a scomparsa, 1 taschino porta penne e cutter, chiusura con zip in metallo e bottone, passanti in vita, trattamento "stone washed", effetto consumato e délavé; gamba diritta, cuciture filo grosso a contrasto ed a triplo ago interno gamba.

-  Denim Stretch 72% Denim + 26% Pol + 2% Elastan
280-300gr/mq
-  42 - 44 - 46 - 48 - 50 - 52 -
54 - 56/58 - 60/62 - 64/66
- 68/70 - 72/74
-  1/20

AY 7327 FOREST SUMMER



Pantalone da Lavoro Elastico in vita, 2 tasche anteriori, 2 tasche laterali, 2 tasche posteriori con chiusura in velcro, taschino portametro.

-  Cotone Drill Ripstop 100%
210 gr/mq
-  XS - S - M - L - XL - XXL - 3XL
-  1/20



AY 7332 FOREST

Pantalone da lavoro multitasche 100% IN COTONE drill 2 tasche anteriori a taglio classico, 2 tasconi a coscia laterali con patta e bottoni automatici, tasca SECUR-ZIP tasca portametro a scomparsa, 2 tasche posteriori a filo chiusura bottoni, passanti ed elastici in vita, cotone prelavato.

-  Cotone - 280 gr/mq
-  XS - S - M - L - XL - XXL
(Blu disponibile anche in 3XL - 4XL)
-  1/20



WORK



THERMO~~PRO~~

BASE LAYER TECHNOLOGY

PERFORMANCE

I Thermo Pro Base Layer sono ideali per le attività ad alta intensità nelle temperature da miti a fredde.

Thermo Pro Base Layer are the perfect match for intense activities in mild and cold temperatures.

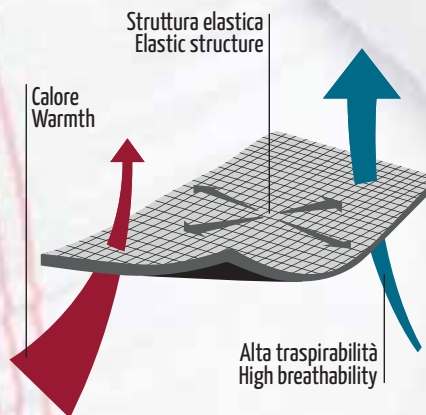

TECNOLOGIA / TECHNOLOGY

Thermo Pro Base Layer garantiscono una termoregolazione costante grazie alle speciali tramature e alle eliche a rilievo che permettono una corretta aerazione. I tagli ergonomici assicurano un migliore adattamento alla fisionomia del corpo e libertà di movimento.

The Thermo Pro Base Layer ensure a constant thermoregulation thanks to their special weaves and to the embossed helixes which allow to have a correct ventilation. The ergonomic cuts ensure a better adaptation to the body appearance as well as more freedom of movement.

GAMMA TERMICA / THERMAL RANGE

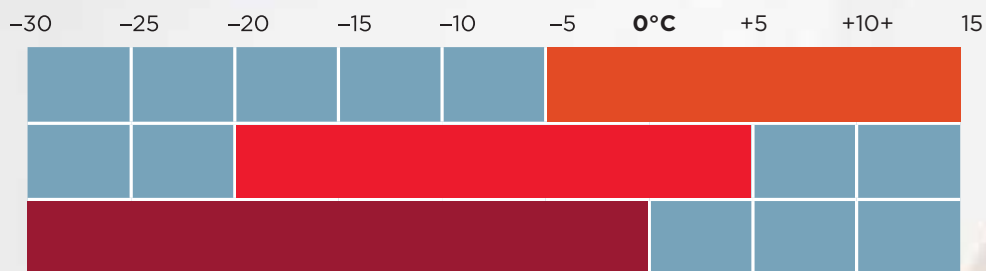



WORK

NE



RY



RETRO



THERMO PRO 160 SS

Maglia termica da uomo, girocollo, maniche corte raglan. Tessuto morbido ed elasticizzato, motivi ad elica in rilievo sui fianchi, per garantire una corretta traspirazione ed una costante termoregolazione. Collo, fondo e orli maniche a costine dello stesso materiale, per un miglior comfort. Struttura tubolare ergonomica per assicurare un perfetto adattamento alla fisionomia del corpo.



65% Poliammide + 35% Poliestere.
160 gr/mq



S/M - L/XL - 2/3XL - 4/5XL



1/30



NE



BI



RETRO



THERMO PRO 280 SS

Maglia termica da uomo, girocollo, maniche corte raglan. Tessuto morbido ed elasticizzato, con speciali tramature sul petto e sulla schiena, motivi ad elica in rilievo sui fianchi, per garantire una corretta traspirazione ed una costante termoregolazione. Collo, fondo e orli maniche a costine dello stesso materiale, per un miglior comfort. Struttura tubolare ergonomica per assicurare un perfetto adattamento alla fisionomia del corpo.



65% Poliammide + 35% Poliestere.
8% Elastane - 280 gr/mq



S/M - L/XL - 2/3XL - 4/5XL



1/30



WORK



THERMO PRO PANT

Pantaloni termici da uomo, con vita e fondi a costina elasticizzata. Zigrinature sul fronte e sul retro, inserto sotto cavallo, per una perfetta vestibilità anatomica. Tramature sul davanti e retro gambe per garantire una corretta traspirazione nelle zone muscolari.



66% Poliammide + 26% Poliestere.
8% Elastane - 240 gr/mq



S/M - L/XL - 2/3XL - 4/5XL



1/30

THERMO PRO LADY

Pantaloni termici da donna, con vita e fondi a costina elasticizzata. Zigrinature sul fronte e sul retro, inserto sotto cavallo, per una perfetta vestibilità anatomica. Tramature sul davanti e retro gambe.



66% Poliammide + 26% Poliestere.
8% Elastane - 240 gr/mq





XS/S - M/L - XL/2L



1/30

THERMO PRO 240 LS

Maglia termica da uomo, girocollo, maniche lunghe raglan. Tessuto morbido ed elasticizzato, con speciali tramature sul petto e sulla schiena, motivi ad elica in rilievo sui fianchi, per garantire una corretta traspirazione ed una costante termoregolazione. Collo, fondo e orli maniche a costine dello stesso materiale, per un miglior comfort. Struttura tubolare ergonomica e speciale zigrinatura sui gomiti, per assicurare un perfetto adattamento alla fisionomia del corpo.

-  66% Poliammide + 26% Poliestere.
8% Elastane - 240 gr/mq
-  S/M - L/XL - 2/3XL - 4/5XL
-  1/30



NEV





RETRO



THERMO PRO 240 LD

Maglia termica da donna, girocollo, maniche lunghe raglan. Tessuto morbido ed elasticizzato, con speciali tramature sul petto e sulla schiena, motivi ad elica in rilievo sui fianchi, per garantire una corretta traspirazione ed una costante termoregolazione. Collo, fondo e orli maniche a costine dello stesso materiale, per un miglior comfort. Struttura tubolare ergonomica e speciale zigrinatura sui gomiti, per assicurare un perfetto adattamento alla fisionomia del corpo.

-  66% Poliammide + 26% Poliestere.
8% Elastane - 240 gr/mq
-  XS/S - M/L - XL/2L
-  1/30



NE



RETRO





NE



RETRO



WORK

TERMO PRO 280 LS

Maglia termica da uomo, girocollo, maniche lunghe raglan. Tessuto morbido ed elasticizzato, con speciali tramature sul petto e sulla schiena, motivi ad elica in rilievo sui fianchi, per garantire una corretta traspirazione ed una costante termoregolazione. Collo, fondo e orli maniche a costine dello stesso materiale, per un miglior comfort. Struttura tubolare ergonomica e speciale zigrinatura sui gomiti, per assicurare un perfetto adattamento alla fisionomia del corpo.



65% Poliammide + 35% Poliestere.
280 gr/mq



S/M - L/XL - 2/3XL - 4/5XL



1/30



B0



B0





NE





NE

**AY 7340
GREMBIULE UOMO**

-  Cotone 65%, poliestere 35%
260 g/mq.
-  100x86 cm
-  10/50



**AY 7345
GREMBIULE DONNA**

-  Cotone 65%, poliestere 35%
260 g/mq.
-  57x70 cm
-  10/80





**AY 7347
GREMBIULE UOMO**

Con finto Gilet con 2 tasconi.



-  Gabardine in Policotone 65%, Poliestere 35% - 180 g/mq
-  100x86 cm
-  1/50

**AY 7350
GREMBIULE DONNA**

Con finto Gilet con 2 tasconi.

-  Gabardine in Policotone 65%, Poliestere 35% - 180 g/mq
-  68x87 cm
-  1/50

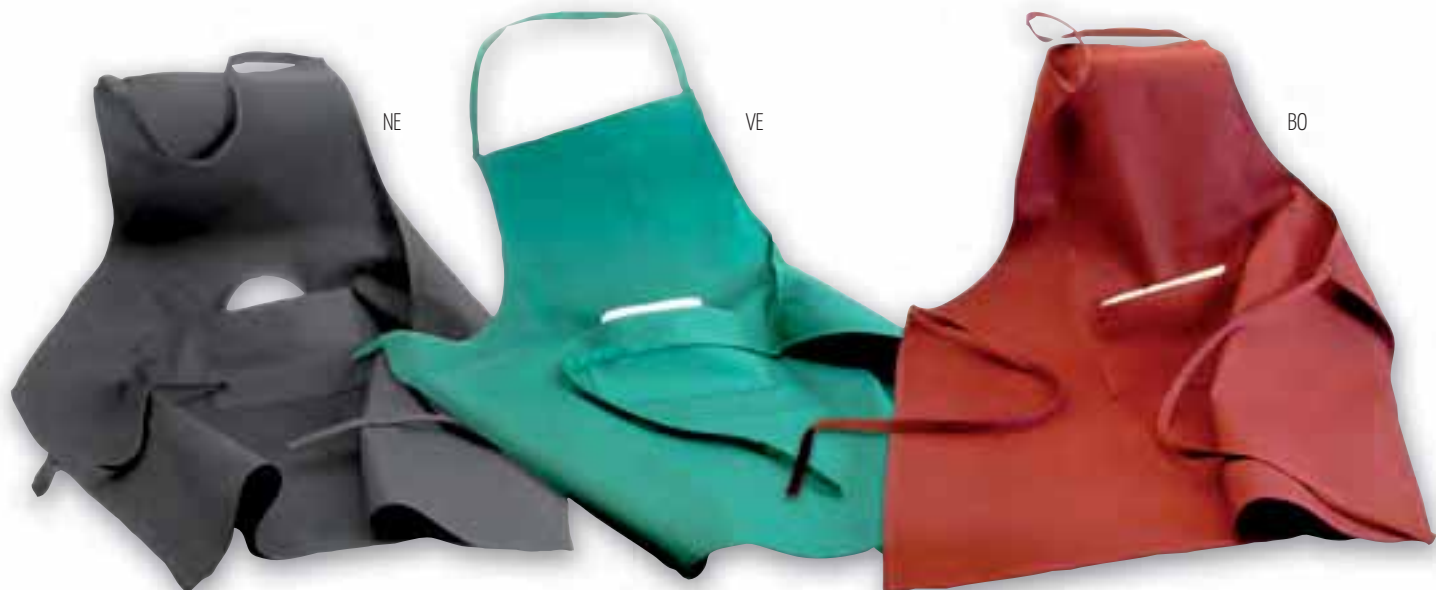

**AY 7358
GREMBIULE
CON TASCONE**

-  Cotone pesante 100%
210 g/mq.
-  67x84 cm
-  10/80



**AY 7365
GREMBIULE BIANCO**

Con tascone.

-  Cotone pesante 100% - 195 g/mq.
-  65x80 cm
-  10/100





BO



BL



VE



NE



MA



**AY 7360
GREMBIULE
BARMAN**

Con 3 tasche



Cotone 100% - 210 gr/mq



56x36 cm





10/50



**AY 7359
GREMBIULE**

Con tasca frontale cucita.

	TNT
	73x50 cm
	10/50

promosolution 2020|2021

T-SHIRT

POLO

FELPE

PILE

GIUBBINI

GILET

WORK

CAPPELLI







AR



**AY 7370
GOLF ADULTO**

Cappello 5 pannelli, fascia tergisudore, occhielli ricamati, frontale rinforzato, visiera rigida sagomata, regolatore misura in velcro, colori reattivi.

-  100% cotone drill 108/58
-  Taglia Unica
-  50/200





BI



VE



VM



RO



AR



GI



BL



RY



AY 7369
GOLF BAMBINO

Cappello 5 pannelli, fascia tergisudore, occhietti ricamati, frontale rinforzato, visiera rigida sagomata, regolatore misura in velcro, colori reattivi.



100% cotone drill 108/58



Taglia Unica



50/200





GI



**AY 7397
SANDWICH**

Cappello 5 pannelli, fascia tergisudore, occhiali ricamati, frontale rinforzato, visiera rigida sagomata e bordata, regolatore misura in velcro, colori reattivi.



100% cotone drill 108/58



Taglia Unica





50/200





**AY 7377
ITALY**

Cappello 5 pannelli, con bandierina Italia ricamata lateralmente, fascia tergisudore, occhietti ricamati, frontale rinforzato, visiera rigida sagomata e bordata, regolatore misura in velcro, colori reattivi.

-  100% cotone drill 108/58
-  Taglia Unica
-  50/200

BI/VM



BI/VE



BI/BL



BI/RV



BI/RO



BI/AR



**AY 7375
ESTORIL**

Cappellino 5 pannelli , occhielli e bordo visiera a contrasto, fascia tergisudore, visiera rigida sagomata, regolatore misura in velcro, misto cotone e poliestere adatto alla sublimazione.



Cotone + Poliestere



Taglia Unica



50/200





GI



RO



AR



VE



BI

NE

AY 7385 SHINY

Cappello Bicolore 5 pannelli, fascia tergisudore, occhielli ricamati, frontale rinforzato, visiera rigida sagomata e bordata, regolatore misura in velcro, colori reattivi.

 100% cotone drill 108/58

 Taglia Unica

 50/200

AY 7380 MESH

Cappello 5 pannelli, fascia tergisudore, occhielli ricamati, frontale rinforzato, visiera rigida sagomata e bordata, regolatore misura in velcro, segmenti posteriori in rete.

 Cotone + Poliestere

 Taglia Unica

 50/200

**AY 7378
USAIR**

Cappellino 5 pannelli mimetico, fascia tergisudore, occhielli ricamati, visiera rigida sagomata, regolatore misura in velcro.



100% cotone drill



Taglia Unica



50/200

**AY 7379
HUNTING**

Cappellino mimetico , visiera rigida sagomata, regolatore misura in velcro.



100% cotone drill



Taglia Unica



50/200







EC





AY 7400
MIRAMARE

Cappellino miramare 100% cotone.

-  100% cotone
-  Ø 25 cm
-  50/300

**AY 7402
FOULARD**

Foulard multifunzione in poliestere con 9 diverse varianti di indossabilità per protezione da calore, freddo e vento

-  Poliestere
-  Taglia Unica
-  25/250

FX



RO



NE



BL



**AY 7401
BANDANA**

-  Cotone + Poliestere
-  Taglia Unica
-  100/500

NE



BI



BL



GI



RO







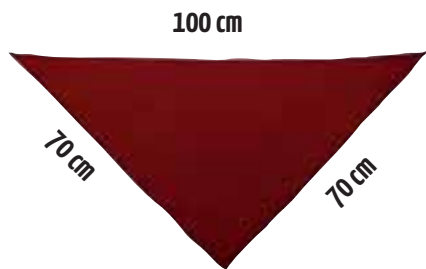

**AY 7398
FOULARD**

Foulard uomo/donna di forma triangolare
tatto cotone, adatto alla sublimazione.



-  100% Poliestere - 65 gr/mq
-  100 x H. 50 cm
-  100/200
-  

**AY 7425
ZUCCOTTO**

-  100% Acrilico - 75 gr/mq
-  Taglia Unica
-  20/200

RY



RO



NE



GR



BL



**AY 7425E
ZUCCOTTO**

-  100% Acrilico - 75 gr/mq
-  Taglia Unica
-  20/200

RY



RO



NE



GR



BL



**AY 7427
ZUCCOTTO**

 Poliestere Pile - 200 gr/mq

 Taglia Unica

 50/200

RO



BL



NE



GR



**AY 7427E
ZUCCOTTO**

 Poliestere Pile - 200 gr/mq

 Taglia Unica

 50/200

RO



BL



NE



GR



AY 7403
FASCIA
SCALDACOLLO

Trasformabile in cappello grazie alla coulisse.

-  Pile - 200 gr/mq
-  Taglia Unica
-  50/200

NE



RO



BL



RY

AY 7403E
FASCIA
SCALDACOLLO

Trasformabile in cappello grazie alla coulisse.

-  Pile - 200 gr/mq
-  Taglia Unica
-  50/200

NE



RO



BL



RY

